



# *CLOCK PARTS*

## INTRODUCTION

*HISTORY:* Clocks have a long and glorious history. Mankind has measured time in many ways but the invention of clock-work using controlled wheels and gearing represented a major human achievement. Brass ornamentation, added to clocks of all types for many centuries and usually silvered or gilded, has been used to emphasise and celebrate the importance of a timepiece. As furniture, clocks have always projected the design differences between national cultures and periods in a way not equalled by most other types of furniture

*ORIGINS:* Most of the parts shown through this catalogue were first made as copies from originals sent to us by our customers and are faithful lost-wax replicas of period originals.

*USING THE CATALOGUE:* A contents page follows to help you to the right pages. All clock parts are shown as true to life size as possible in the printed version. Full measurements are also given for the convenience of those looking at a PDF download. As the majority of the clock parts in this supplement are made to order we **strongly** recommend that you purchase an initial sample (if you are in doubt as to whether the item will suit your purpose) before making a decision about a larger order. Some items are held in stock, and through the catalogue you will see each of these shown with their Main Catalogue order code in brackets and you can search for these on our website. All multiple component items are sold fully assembled - our ball and spire finials are assembled traditionally with a threaded rod linking through from the spire to the base. Fixing screws or pins can also be ordered with a matching finish for those items that need them.

---

# Contents

Spandrels.....	Pages 3 to 8
Finials .....	Pages 9 to 20
Paterae.....	Pages 21 to 25
Escutcheons.....	Pages 26 to 33
Decorative Side Panel Grilles/Frets.....	Pages 34 and 35
Mounts.....	Pages 36 to 40
Capitals.....	Pages 41 to 49
Feet.....	Pages 50 to 57
Hinges.....	Pages 58 and 59
Carrying Handles.....	Pages 60 and 61
Brackets and Door Fastenings.....	Page 62

SPANDRELS

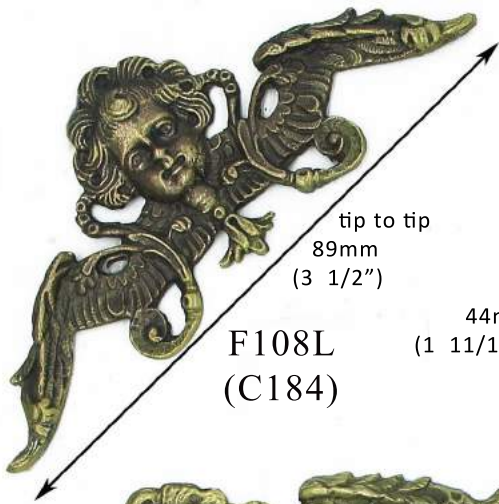

F108L  
(C184)

tip to tip  
89mm  
(3 1/2")

44mm  
(1 11/16")



F106L

44mm (1 11/16")

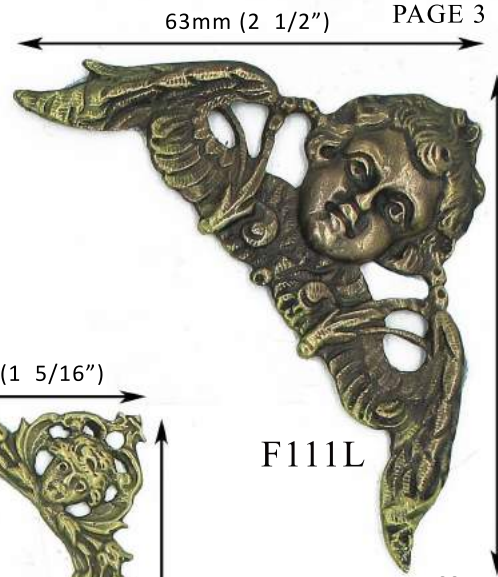

F111L

63mm (2 1/2")

68mm  
(2 11/16")

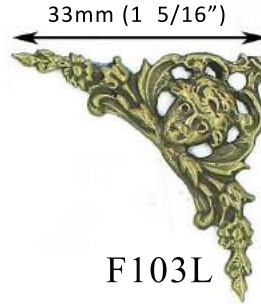

F103L

33mm (1 5/16")

33mm  
(1 5/16")

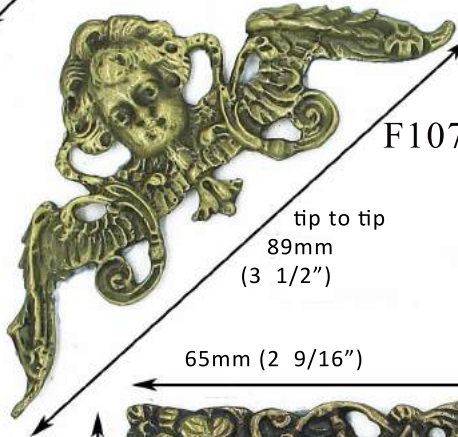

F107L

tip to tip  
89mm  
(3 1/2")

65mm (2 9/16")

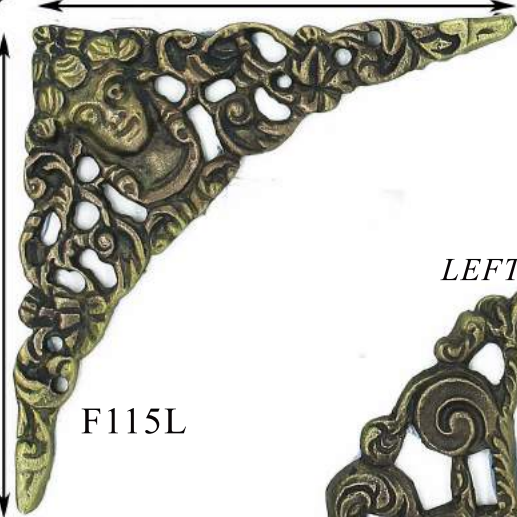

F115L

65mm  
(2 9/16")

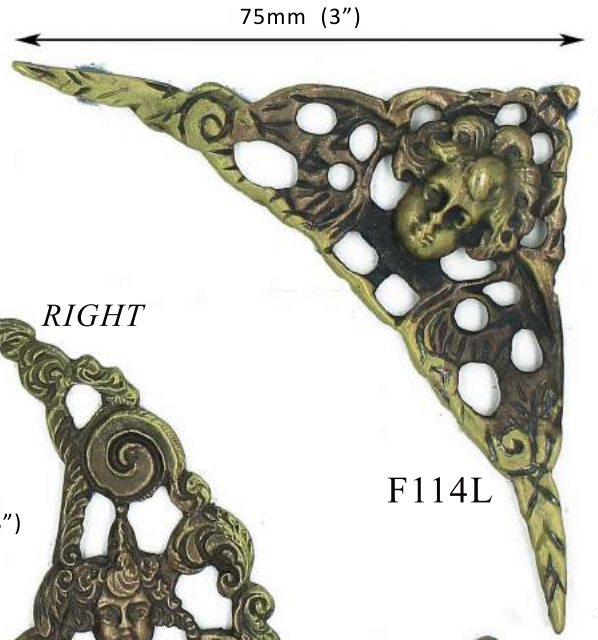

F114L

75mm (3")



LEFT

46mm (1 13/16")



RIGHT

45mm (1 13/16")

54mm  
(2 1/8")

F119L  
sold as a  
pair



F141L  
sold as a  
left and right  
handed pair

height  
66mm (2 5/8")      width  
53mm (2 1/8")



F110L

height 83mm (3 1/4")  
width 84mm (3 5/16")



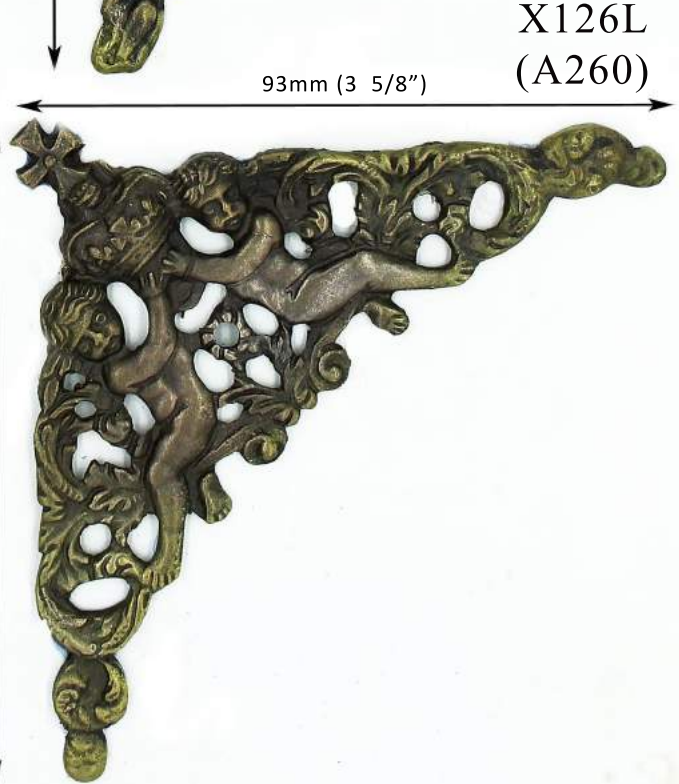
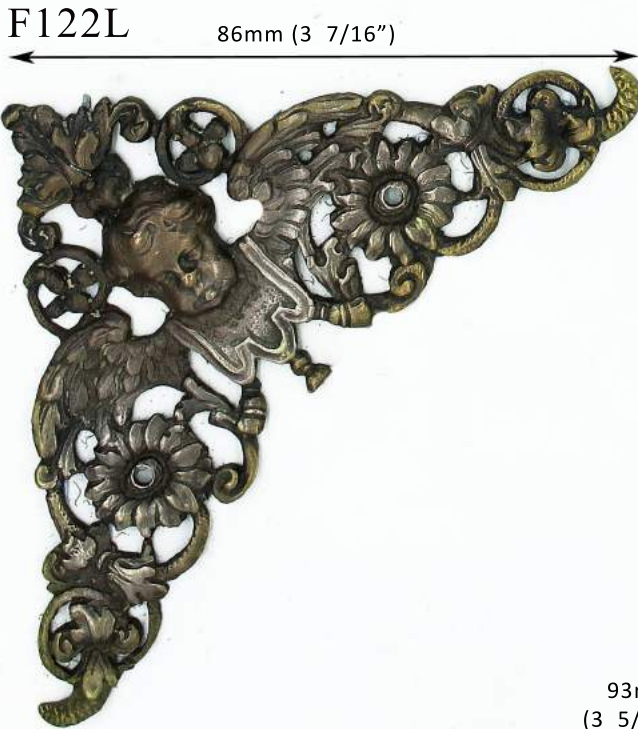
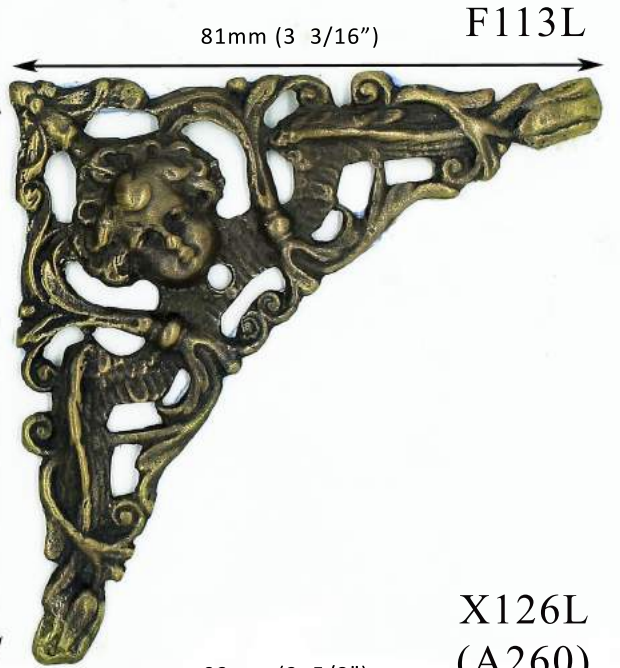
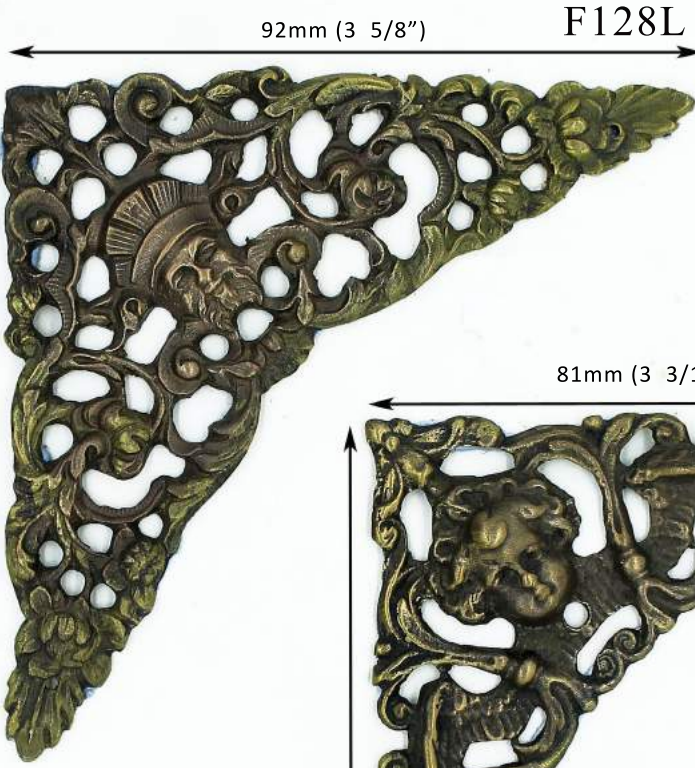
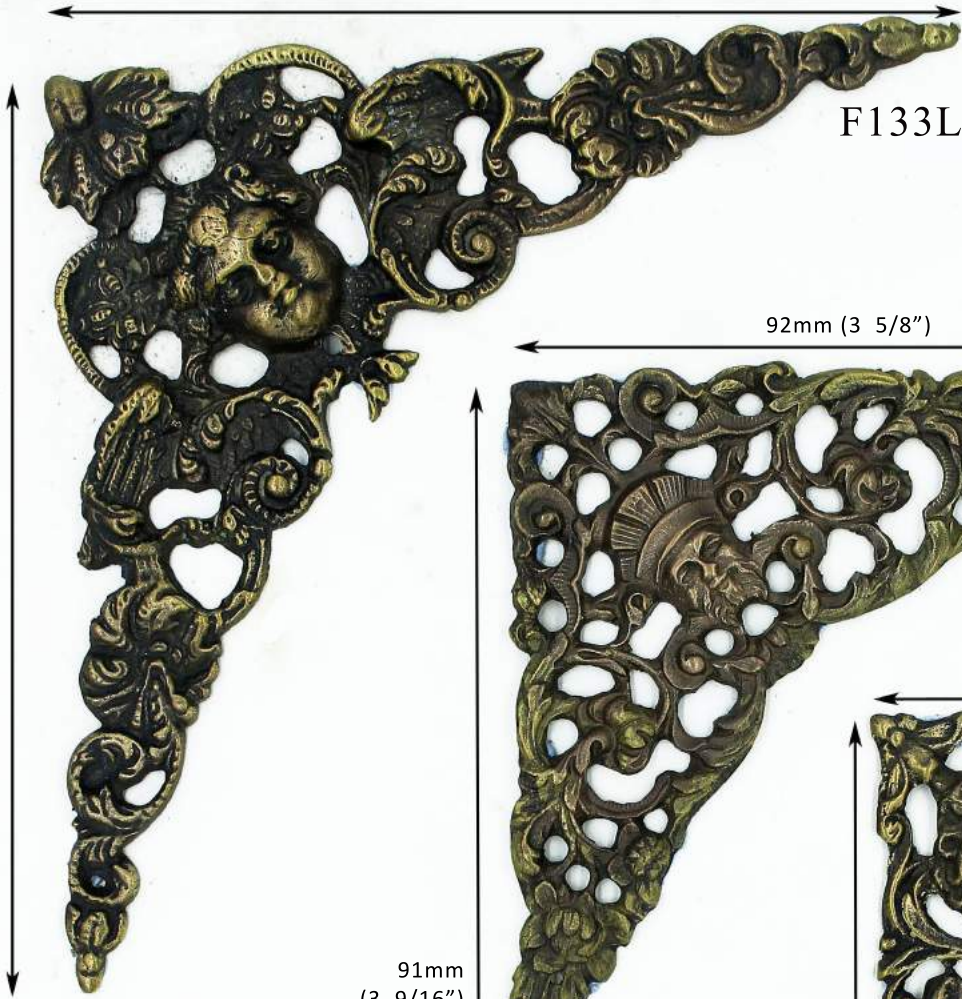

85mm (3 5/16")

93mm (3 5/8")



107mm (4 1/4")

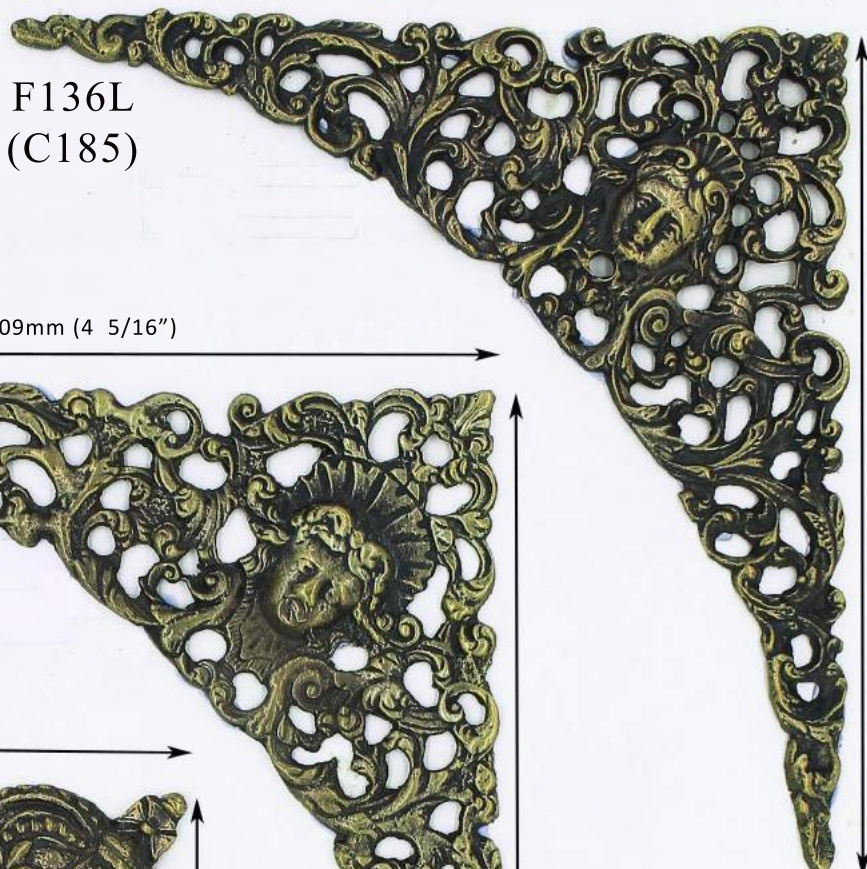

F136L  
(C185)

109mm (4 5/16")

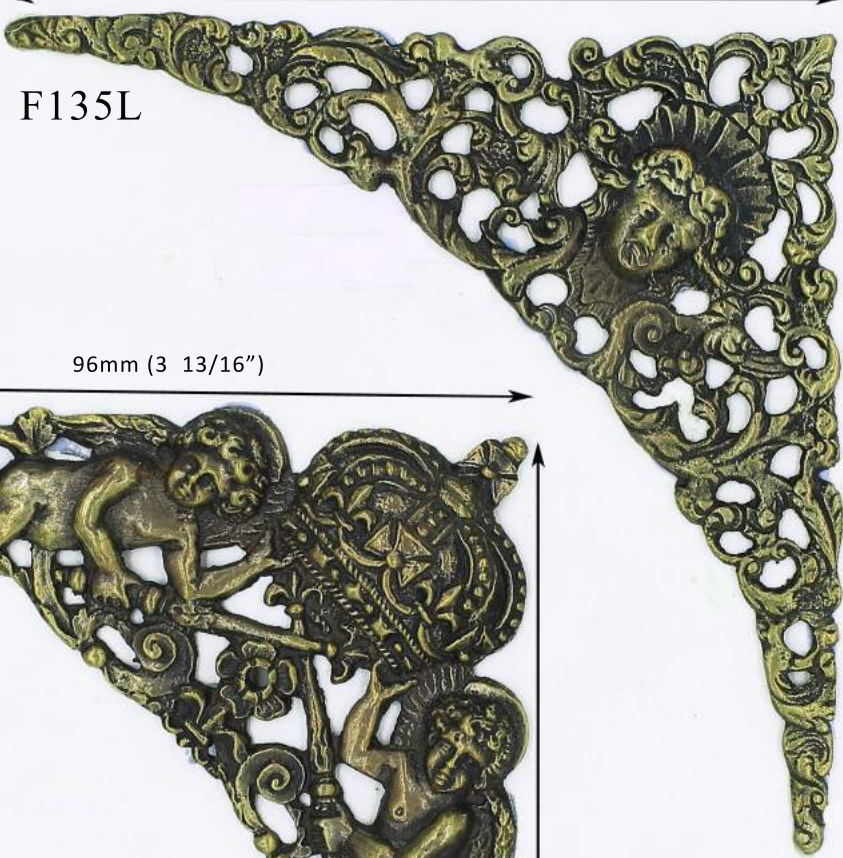

F135L

96mm (3 13/16")

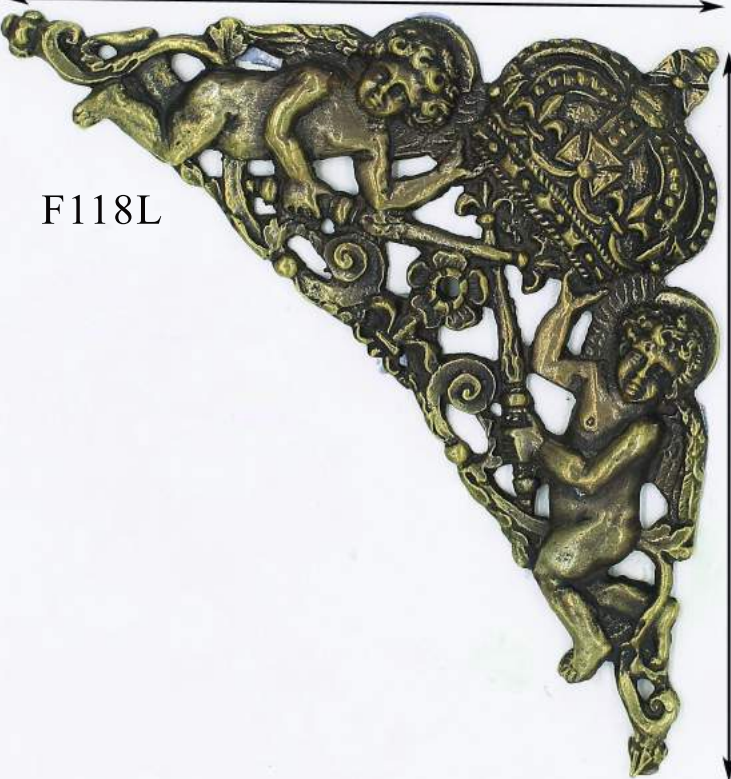

F118L

99mm  
(3 15/16")

108mm  
(4 1/4")

107mm  
(4 1/4")

109mm  
(4 5/16")

F139L

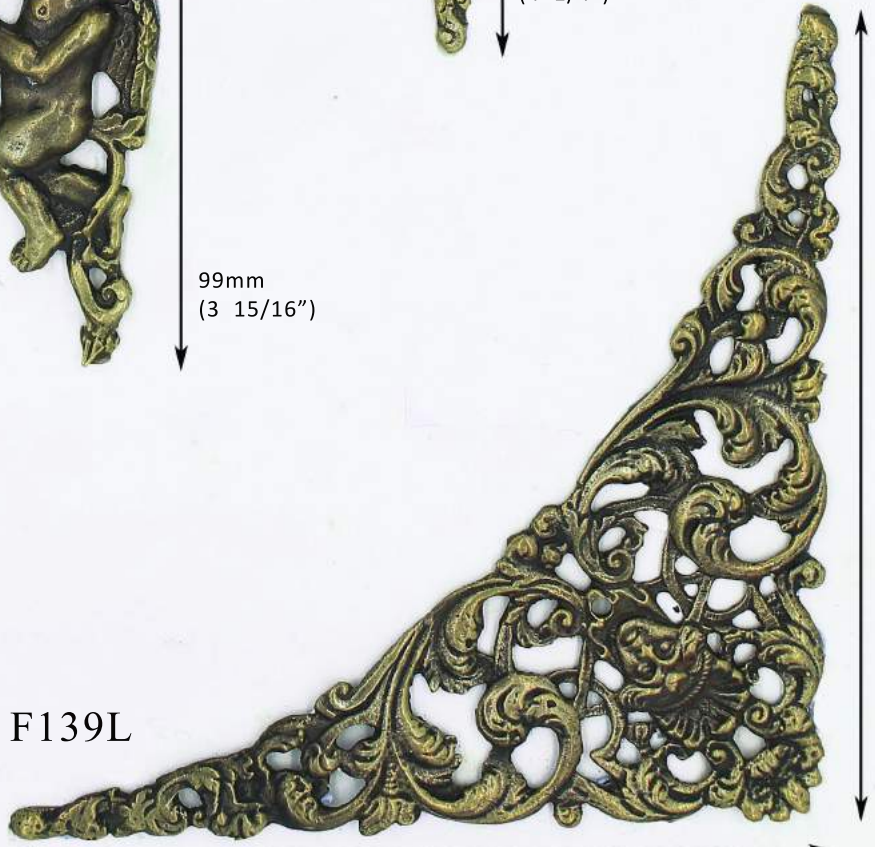

110mm (4 3/8")



111mm  
(4 3/8")

109mm (4 5/16")

F137L

95mm  
(3 3/4")

77mm (3 1/16")

F116L

79mm  
(3 1/8")

3145L

120mm (4 3/4")

93mm (3 11/16")

137mm  
(5 7/16")

72mm (2 7/8")

F132L

F112L

28mm  
(1 1/8")

72mm  
(2 7/8")

F101L

F105L

F134L

28mm  
(1 1/8")

120mm  
(4 3/4")

44mm  
(1 11/16")

45mm (1 3/4")

135mm  
(5 3/8")

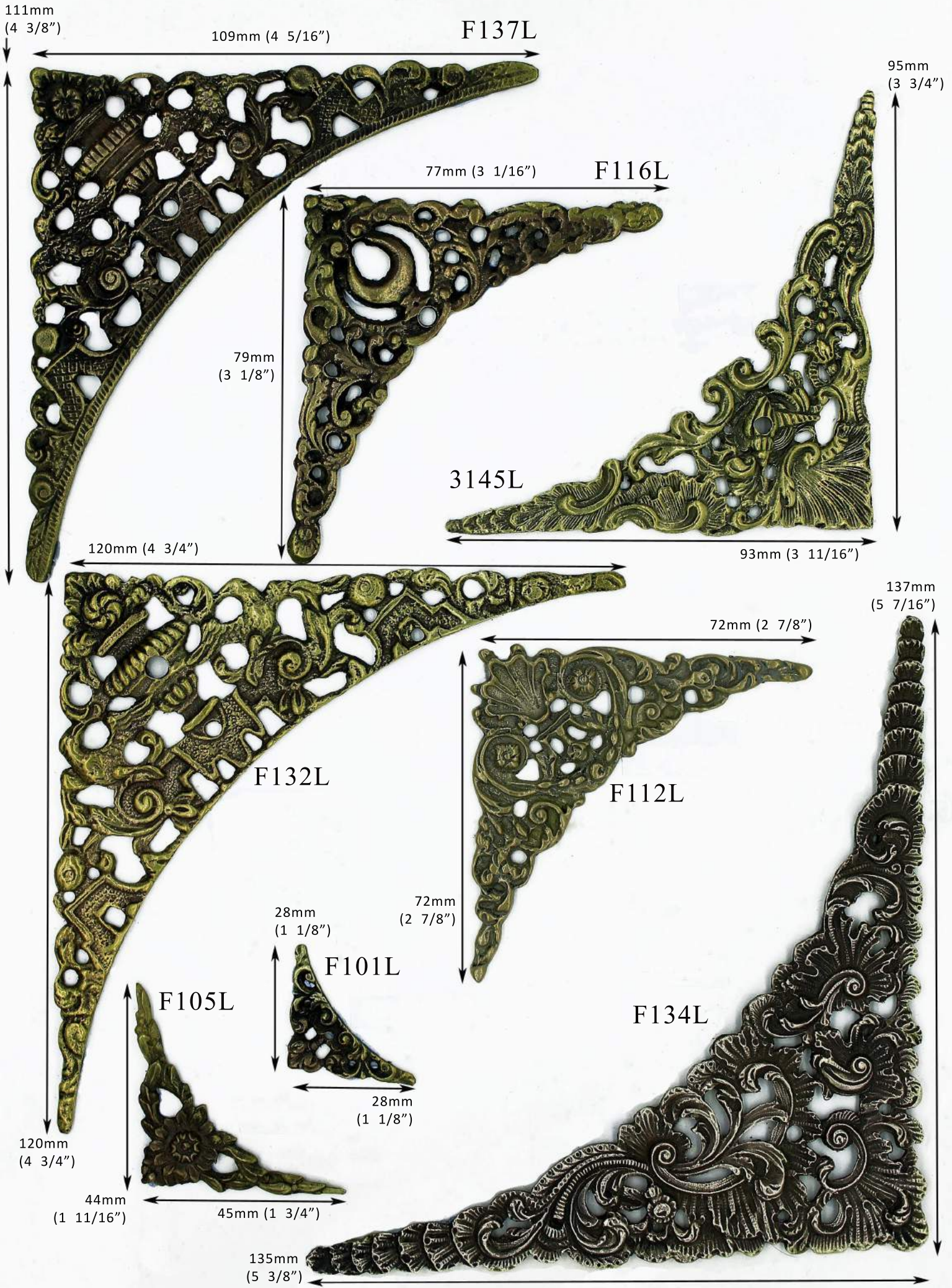



1264L

142mm (5 5/8")

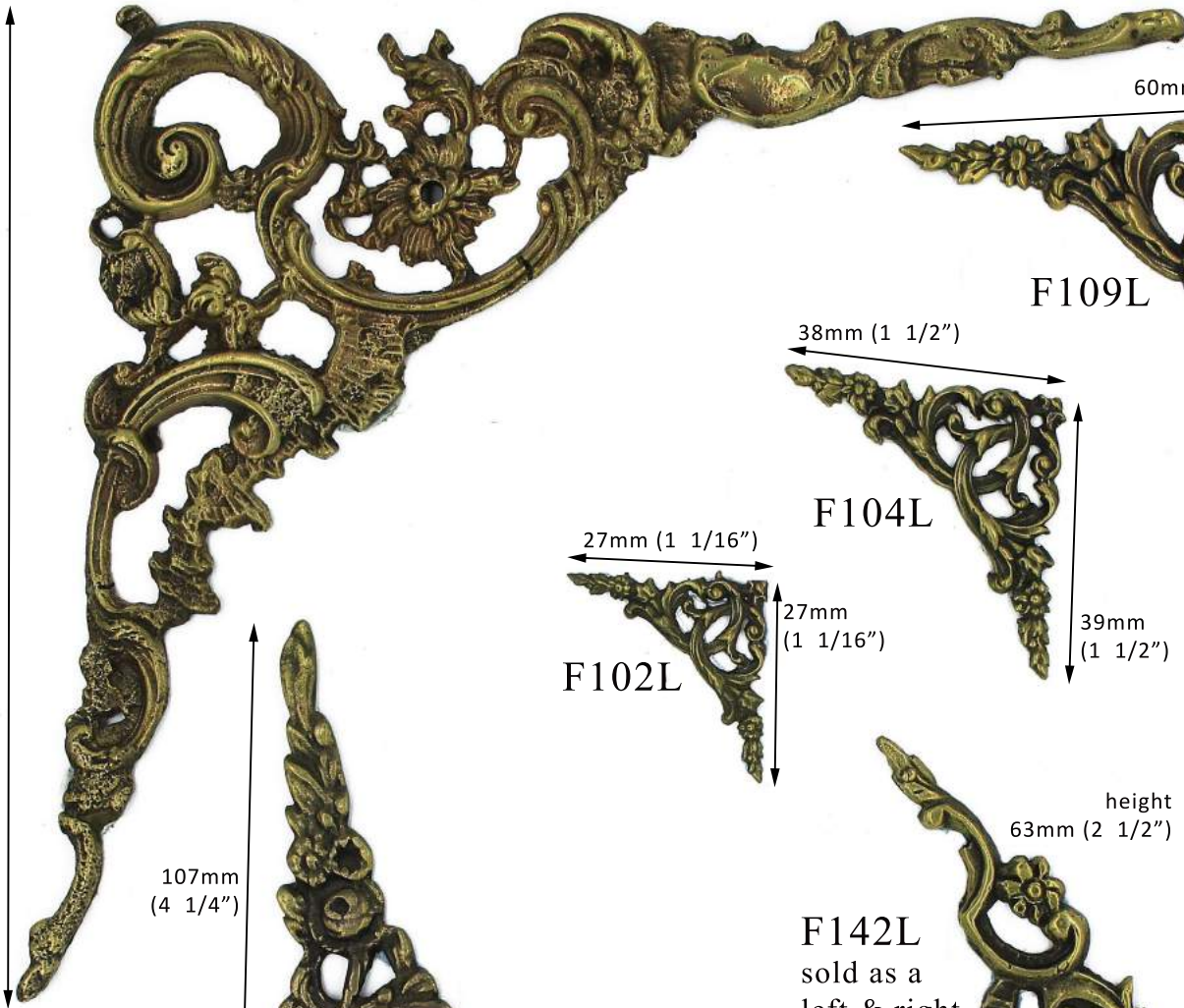

134mm (5 5/16")

107mm (4 1/4")

60mm (2 3/8")

F109L

38mm (1 1/2")

F104L

27mm (1 1/16")

F102L

27mm (1 1/16")

39mm (1 1/2")

58mm (2 5/16")

height 63mm (2 1/2")

F142L

sold as a left & right handed pair

49mm (1 15/16")

F124L

109mm (4 5/16")

F121L

93mm (3 11/16")

89mm (3 1/2")

XF138L (C183)

each corner to tip 113mm (4 7/16")



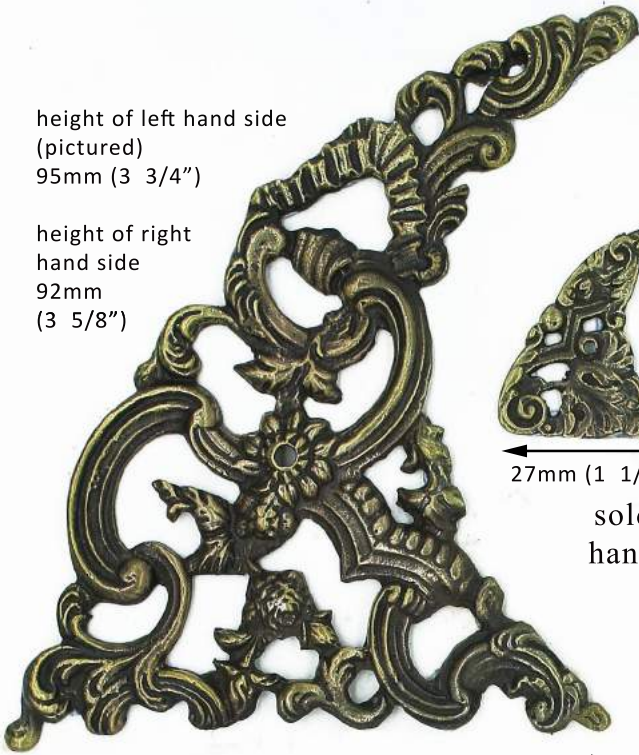

height of left hand side  
(pictured)  
95mm (3 3/4")

height of right  
hand side  
92mm  
(3 5/8")

left hand width (shown) 81mm (3 3/16")  
right hand width 78mm (3 1/16")

F143L (C182)

sold as a left & right handed  
pair, **left hand** side shown here

height 29mm  
(1 1/8")



27mm (1 1/16")

27mm (1 1/16")

F123L

sold as a left & right  
handed pair as shown



height of right hand side  
(pictured)  
97mm (3 7/8")

height of left  
hand side  
97mm  
(3 7/8")

86mm (3 3/8")

F144L

sold as a left & right handed  
pair, **right hand** side shown here

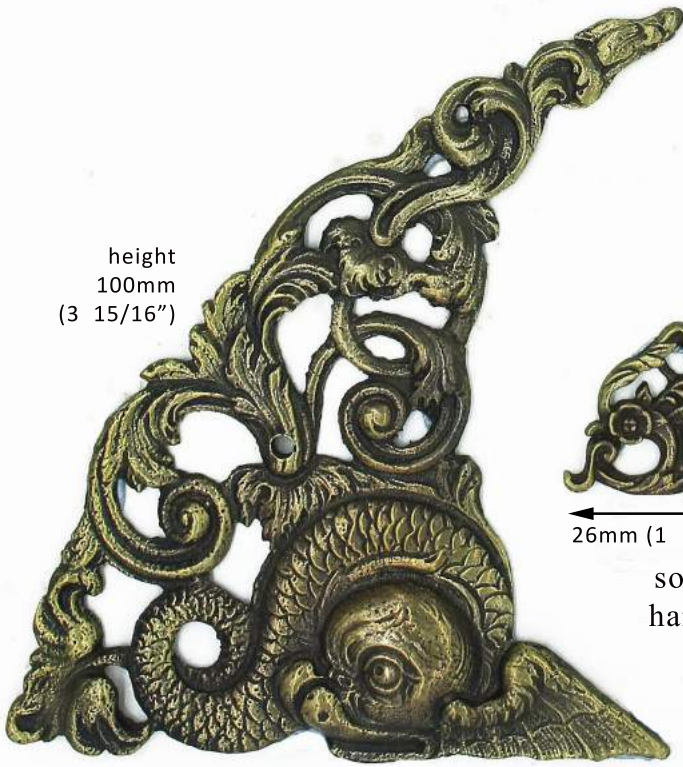

height  
100mm  
(3 15/16")

90mm (3 9/16")

F145L

sold as a left & right handed  
pair, **left hand** side shown here

height  
26mm  
(1 1/16")



26mm (1 1/16")



26mm (1 1/16")

F120L

sold as a left & right  
handed pair as shown

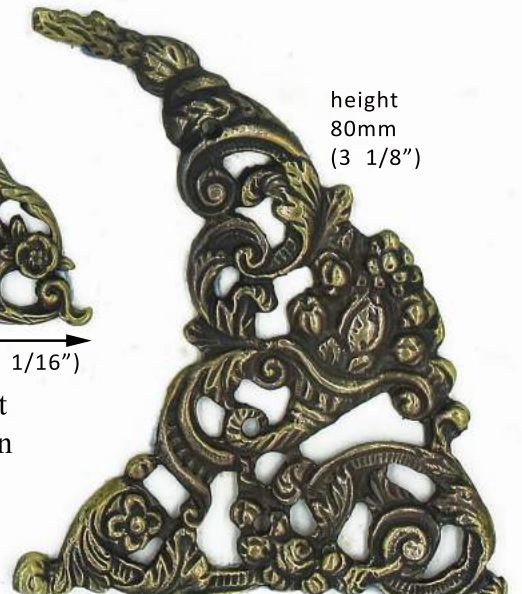

height  
80mm  
(3 1/8")

66mm (2 9/16")

F146L

sold as a left & right handed  
pair, **right hand** side shown here





1595CSPIRE  
3372BALL/C175BASE

overall height (excluding fixing post)  
116mm (4 5/8")  
dia. at centre 57mm (2 1/4")



3373L

overall height (excluding fixing post)  
156mm (6 1/8")  
dia. at centre 61mm (2 7/16")



3372L

overall height (excluding fixing post)  
131mm (5 1/8")  
dia. at centre 57mm (2 1/4")



X1961L  
(C175)

overall height (excluding fixing post)  
108mm (4 1/4")  
dia. at centre 49mm (1 15/16")



3381L

overall height (excluding fixing post)  
90mm (3 9/16")  
dia. at centre 43mm (1 11/16")



X1922L  
(C176)

overall height (excluding fixing screw)  
96mm (3 3/4")  
dia. at centre 50 mm (1 15/16")





6847L

overall height (excluding fixing post)  
147mm (5 13/16")  
dia. at centre 60mm (2 3/8")



6452L

overall height (excluding fixing post)  
139mm (5 1/2")  
dia. at centre 69mm (2 3/4")



3374L

overall height (excluding fixing screw)  
117mm (4 5/8")  
dia. at centre 54mm (2 1/8")



6386L

overall height (excluding fixing screw)  
97mm (3 7/8")  
max.dia. 67mm (2 5/8")



6352L

overall height (excluding fixing post)  
92mm (3 5/8")  
dia. at centre 68mm (2 11/16")



2698L



overall height (excluding fixing screw)  
86mm (3 3/8")  
dia. at centre 52mm (2 1/16")

6385L



overall height (excluding fixing post)  
97mm (3 7/8")  
dia. at centre 60mm (2 3/8")

6450L



overall height (excluding fixing post)  
77mm (3 1/16")  
dia. at centre 68mm (2 11/16")

FINIALS  
X1401L(B56)

1567L



height (ex. pin)  
21mm (7/8")  
max. width 7mm (1/4")  
dia. at base 6mm (1/4")

1568L



height (ex. pin)  
29mm (1 1/8")  
max. width 10mm (3/8")  
dia. at base 7mm (5/16")



height (ex. screw)  
36mm (1 7/16")  
max. width 12mm (1/2")  
dia. at base 10mm (3/8")

1531L



height (ex. screw)  
18mm (3/4")  
max. width 9mm (3/8")  
dia. at base 8mm (5/16")

1532L



height (ex. screw)  
19mm (3/4")  
max. width 11mm (7/16")  
dia. at base 9mm (3/8")

F130L



height (ex. pin)  
44mm (1 3/4")  
max. width 17mm (11/16")  
dia. at base 10mm (7/16")

3282L



height (ex. screw)  
45mm (1 13/16")  
max. width 20mm (13/16")  
dia. at base 17mm (11/16")

7349L



height (ex. screw)  
54mm (2 3/16")  
max. width 22mm (7/8")  
dia. at base 12mm (1/2")

7062L



height (ex. screw)  
34mm (1 3/8")  
max. width 16mm (5/8")  
dia. at base 11mm (7/16")

1892L



height (ex. screw)  
69mm (2 3/4")  
max. width 25mm (1")  
dia. at base 12mm (1/2")

7302L



height (ex. screw)  
73mm (2 7/8")  
max. width 25mm (1")  
dia. at base 21mm (13/16")

6413L



2 PARTS height with base but  
ex.screw 55mm (2 3/16")  
max. width of finial 19mm (3/4")  
base is 20mm (13/16") square  
dia. at finial base 11mm (7/16")

6218L



height (ex. screw)  
41mm (1 5/8")  
max. width 19mm (3/4")  
dia. at base 11mm (7/16")

6685L



height (ex. screw)  
66mm (2 9/16")  
max. width 24mm (15/16")  
dia. at base 9mm (3/8")

3376L



**CAST WITH THREADED  
HOLE AT BASE**  
height 65mm (2 9/16")  
max. width 25mm (1")  
dia. at base 13mm (1/2")

3377L



**CAST WITH THREADED  
HOLE AT BASE**  
height 87mm (3 7/16")  
max. width 35mm (1 3/8")  
dia. at base 17mm (11/16")

3378L



**CAST WITH THREADED  
HOLE AT BASE**  
height 100mm (4")  
max. width 39mm (1 9/16")  
dia. at base 21mm (13/16")

2347L



height (ex. screw)  
73mm (2 7/8")  
max. width 38mm (1 1/2")  
dia. at base 31mm (1 3/16")

3360L



height (ex. flat fixing tab)  
80mm (3 1/8")  
max. width 35mm (1 3/8")  
base is 38mm (1 1/2") square

3375L



height (ex. pin)  
89mm (3 1/2")  
max. width  
38mm (1 1/2")  
dia. at base 12mm (1/2")



FINIALS

1736L



height (ex. screw)  
36mm (1 7/16")  
max. width 21mm (13/16")  
dia. at base 14mm (9/16")

1735L



height (ex. screw)  
44mm (1 3/4")  
max. width 23mm (15/16")  
dia. at base 14mm (9/16")

F159L



height (ex. screw)  
44mm (1 3/4")  
max. width 21mm (13/16")  
dia. at base 8mm (5/16")

8061L



height (ex. screw)  
44mm (1 3/4")  
max. width 32mm (1 1/4")  
dia. at base 22mm (7/8")

3055L



cast with small threaded  
hole in the base  
height 27mm (1 1/16")  
max. width 13mm (1/2")  
dia. at base 13mm (1/2")

2762L



height (ex. screw)  
25mm (1")  
max. width 14mm (9/16")  
dia. at base 10mm (3/8")

7925L



height (ex. pin)  
26mm (1 1/16")  
max. width 16mm (5/8")  
dia. at base 11mm (7/16")

2796L



cast with threaded hole  
in the base  
height 32mm (1 1/4")  
max. dia. is at base  
18mm (11/16")

2268L



height (ex. screw)  
22mm (7/8")  
max. dia. is at base  
9mm (3/8")

2518L



height (ex. screw)  
25mm (1")  
max. width 13mm (1/2")  
dia. at base 12mm (7/16")

3379L



height (ex. screw)  
53mm (2 1/16")  
max. width 26mm (1 1/16")  
dia. at base 24mm (15/16")

X1643L  
(C174)



height (ex. screw)  
67mm (2 5/8")  
max. width 28mm (1 1/8")  
dia. at base 13mm (1/2")

7931L



height (ex. screw)  
82mm (3 1/4")  
max. width 36mm (1 7/16")  
dia. at base 14mm (9/16")

3838L



height (ex. screw)  
82mm (3 1/4")  
max. width 36mm (1 7/16")  
dia. at base 14mm (9/16")

7022L



height (ex. screw)  
72mm (2 13/16")  
max. width 26mm (1 1/16")  
dia. at base 16mm (5/8")

1504L



cast without fixing,  
please tell us what you need  
height 43mm (1 11/16")  
max. width 17mm (11/16")  
dia. at base 8mm (5/16")

X2839L  
(C173)



height (ex. screw)  
58mm (2 5/16")  
max. width 19mm (3/4")  
dia. at base 15mm (9/16")

7629L



height (ex. screw)  
57mm (2 1/4")  
max. width 29mm (1 1/8")  
dia. at base 11mm (7/16")

7023L



height (ex. screw)  
47mm (1 7/8")  
max. width 20mm (13/16")  
dia. at base 11mm (7/16")



height (ex. pin)  
71mm (2 13/16")  
max. width 33mm (1 5/16")  
dia. at base 14mm (9/16")

8130L



F54L



height (ex. screw)  
18mm (11/16")  
max. width 15mm (5/8")

929L



cast with threaded hole  
height 27mm (1 1/16")  
max. width 16mm (11/16")  
dia. at base 11mm (7/16")

F129L



height (ex. stub)  
26mm (1")  
max. width 16mm (11/16")  
dia. at base 12mm (1/2")

573L



cast without fixing,  
please tell us what you need  
height 36mm (1 7/16")  
max. width 24mm (15/16")  
dia. at base 14mm (9/16")

1191L



height (ex. pin)  
27mm (1 1/16")  
max. width 16mm (5/8")  
dia. at base 9mm (3/8")

F16BL



height (ex. pin)  
24mm (15/16")  
max. width 14mm (9/16")  
dia. at base 10mm (7/16")

2255L



height (ex. screw)  
27mm (1 1/8")  
max. width 12mm (1/2")  
dia. at base 11mm (7/16")

F158L



height (ex. screw)  
36mm (1 7/16")  
max. width is at base  
21mm (13/16")

F149L



height (ex. stub)  
24mm (15/16")  
max. width 13mm (1/2")  
dia. at base 11mm (7/16")

3138L



cast without fixing  
please tell us what you need  
height 31mm (1 1/4")  
max. width 13mm (9/16")  
dia. at base 9mm (3/8")

2209L



height (ex. screw)  
29mm (1 1/8")  
max. width 12mm (1/2")  
dia. at base 10mm (3/8")

1337L



height (ex. pin)  
37mm (1 7/16")  
max. width 13mm (1/2")  
dia. at base 10mm (3/8")

X828L  
(B55)



height (ex. stub)  
28mm (1 1/8")  
max. width 19mm (3/4")  
dia. at base 12mm (1/2")

2617L



cast without fixing,  
please tell us what you need  
height 30mm (1 3/16")  
max. width 17mm (11/16")  
dia. at base 10mm (3/8")

1933L



cast without fixing  
please tell us what you need  
height 31mm (1 1/4")  
max. width 20mm (13/16")  
dia. at base 13mm (1/2")

3739L



cast without fixing  
please tell us what you need  
height 34mm (1 5/16")  
max. width 18mm (3/4")  
dia. at base 16mm (5/8")

6105L



height (ex. screw)  
31mm (1 1/4")  
max. width 19mm (3/4")  
dia. at base 12mm (1/2")

XF140L  
(C172)



height (ex. screw)  
41mm (1 5/8")  
max. width 23mm (15/16")  
dia. at base 17mm (11/16")

1174AL



cast without fixing,  
please tell us what you need  
height 43mm (1 11/16")  
max. width 28mm (1 1/8")  
dia. at base 21mm (13/16")

7263L



cast with pilot hole,  
on the underside  
height 46mm (1 13/16")  
max. width 29mm (1 1/8")  
dia. at base 19mm (3/4")

2763L



cast without fixing,  
please tell us what you need  
height 39mm (1 9/16")  
max. width 26mm (1 1/16")  
dia. at base 14mm (9/16")

6816L



height (exc. stub)  
36mm (1 7/16")  
max. width 20mm (13/16")  
dia. at base 17mm (11/16")

1555L



cast without fixing,  
please tell us what you need  
height 46mm (1 13/16")  
max. width is at base  
25mm (1")

2945L



height (exc. screw)  
27mm (1 1/16")  
max. width is at base  
22mm (7/8")

6827L



height 37mm (1 1/2")  
base is a rectangle with  
quadrant corners with  
max. measurements of  
29mm (1 1/8") x 34mm (1 5/16")  
cast with 4 small pin  
holes for fixing



F160L



height (ex. stub)  
26mm (1 1/16")  
max. width 13mm (1/2")  
dia. at base 8mm (5/16")

1505L



height (ex. stub)  
41mm (1 5/8")  
max. width 19mm (3/4")  
dia. at base 12mm (1/2")

7735L



height (ex. pin)  
29mm (1 1/8")  
max. width is at base  
17mm (11/16")

7985L



height (ex. screw)  
38mm (1 1/2")  
max. width 20mm (13/16")  
dia. at base 14mm (9/16")

F155L



height (ex. screw)  
49mm (1 15/16")  
max. width. 21mm (13/16")  
dia. at base 15mm (9/16")

6175L



height (ex. screw)  
44mm (1 3/4")  
max. width 23mm (15/16")  
dia. at base 22mm (7/8")

8039L



height (ex. stub)  
58mm (2 5/16")  
max. width 24mm (15/16")  
dia. at base 12mm (1/2")

8097L



2 PARTS height with  
base but ex.screw  
61mm (2 7/16")  
max. width of finial  
20mm (13/16")  
base is 29mm  
(1 1/8") square  
height of base is  
8mm (5/16")

7757L



height (ex. pin)  
59mm (2 5/16")  
max. width 22mm (7/8")  
dia. at base 11mm (7/16")

2182L



dia.  
36mm  
(1 7/16")  
has central stub on rear for fixing

1341L



dia.  
36mm  
(1 7/16")  
has central spike on rear for fixing

7600L



dia.  
43mm  
(1 11/16")  
has two pin holes for surface mounting

F16AL



dia.  
44mm  
(1 3/4")  
has flange on rear of dia.39mm (1 9/16")  
but cast without fixings

X2298L (B50)



dia.  
57mm  
(2 1/4")  
has two pin holes for surface mounting

3790L



dia.  
19mm  
(3/4")  
has central spike on rear for fixing

7577L



dia.  
31mm  
(1 1/4")  
has central spike on rear for fixing

3713L

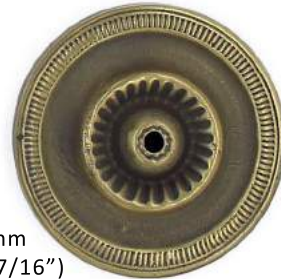

dia.  
36mm  
(1 7/16")  
has central pin hole for surface mounting

2299L

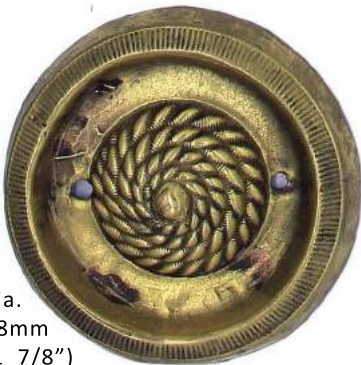

dia.  
48mm  
(1 7/8")  
has two pin holes for surface mounting

2005L



dia.  
47mm  
(1 7/8")  
has two pin holes for surface mounting

2772L



dia.  
49mm  
(1 15/16")  
has two pin holes for surface mounting



PATERAEE

3907L



dia.  
43mm  
(1 11/16")  
cast without fixings

2620L



dia.  
42mm  
(1 11/16")  
cast without fixings

2007L



dia.  
44mm  
(1 3/4")  
cast without fixings

2289L



dia.  
45mm  
(1 13/16")  
has two pin holes for surface mounting

1817L



dia.  
47mm  
(1 7/8")  
has two pin holes for surface mounting

X2006L(B51)



dia.  
45mm  
(1 13/16")  
has two pin holes for surface mounting

6707L

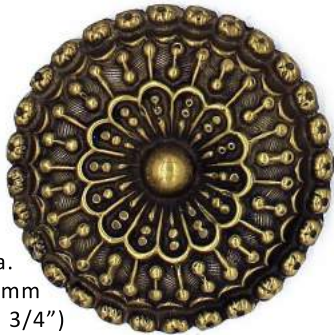

dia.  
44mm  
(1 3/4")  
has central spike on rear for fixing

X3155L(C177)



dia.  
47mm  
(1 13/16")  
has two pin holes for surface mounting

7677L

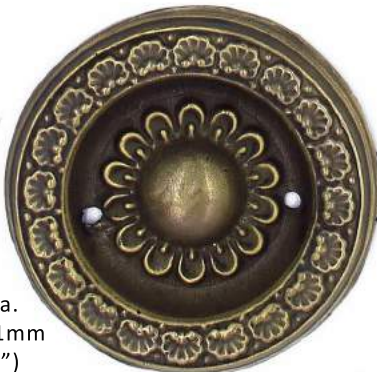

dia.  
51mm  
(2")  
has two pin holes for surface mounting  
**Sorry, this part is no longer available.**

8007L



dia.  
50mm  
(1 15/16")  
has central spike on rear for fixing

1810L



dia.  
47mm  
(1 7/8")  
has two pin holes for surface mounting

2827L



dia.  
48mm  
(1 7/8")  
cast without fixings

3686L



dia.  
58mm  
(2 5/16")  
has two pin holes for surface mounting

1384L



dia.  
55mm  
(2 1/8")  
has two pin holes for surface mounting

2004L



dia.  
54mm  
(2 1/8")  
cast without fixings

673L



dia.  
58mm  
(2 1/4")  
cast with central threaded hole  
on the rear - thread fixing could  
be attached

1485L



max. width  
and height  
49mm (1 15/16")  
has central spike on rear for fixing

6606L



dia.  
57mm  
(2 1/4")  
has two pin holes for surface mounting



PATERAEE

3415L



dia.  
27mm  
(1 1/16")  
has central spike  
on rear for fixing

2926L



dia.  
44mm  
(1 3/4")  
has central spike on rear for fixing

200L



dia.  
50mm  
(2")  
has two spikes on rear for fixing

3884L



dia.  
35mm  
(1 3/8")  
has two pin holes  
for surface mounting

3445L

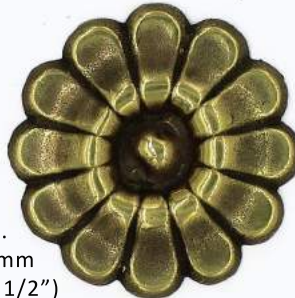

dia.  
38mm  
(1 1/2")  
cast without fixings

3296L



dia.  
43mm  
(1 11/16")  
has central spike on rear for fixing

6200L



dia.  
57mm  
(2 1/4")  
has central spike on rear for fixing

2521L



dia.  
44mm  
(1 3/4")  
has central spike on rear for fixing

X717AL  
(A276)



dia.  
43mm  
(1 11/16")  
has central spike on rear for fixing

X1951L (C178)

2135L

F14DM

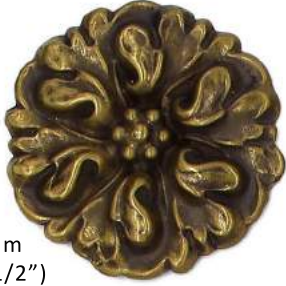

dia.  
38mm  
(1 1/2")  
has central spike  
on rear for fixing



dia.  
54mm  
(2 1/8")  
has central spike on rear for fixing



dia.  
58mm  
(2 1/4")  
has central spike on rear for fixing

6755L

7281L

2290L



dia.  
38mm  
(1 1/2")  
has central spike  
on rear for fixing



dia.  
41mm  
(1 5/8")  
has central spike on rear for fixing



dia.  
39mm  
(1 9/16")  
has central spike on rear for fixing

3112L

2530L



dia.  
49mm  
(1 15/16")  
cast without fixings



dia.  
54mm  
(2 1/8")  
has two pin holes for surface mounting

7813BL

7813AL

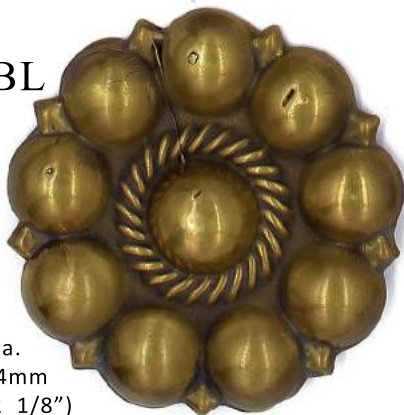

dia.  
54mm  
(2 1/8")  
has central spike on rear for fixing

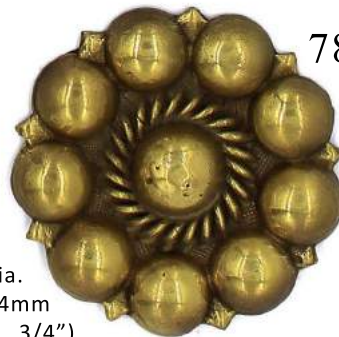

dia.  
44mm  
(1 3/4")  
has central spike on rear for fixing



ESCUTCHEONS

6896L

overall height 98mm (3 7/8")  
max. width 28mm (1 1/8")  
keyhole height 21mm (13/16")



X137L (A31)

overall height 94mm (3 3/4")  
max. width 25mm (1")  
keyhole height 19mm (3/4")



3084L

overall height 81mm (3 1/4")  
max. width 23mm (15/16")  
keyhole height 15mm (5/8")



3083L

overall height 60mm (2 3/8")  
max. width 23mm (7/8")  
keyhole height 15mm (5/8")



6202L

overall height 76mm (3")  
max. width 38mm (1 1/2")  
keyhole height 19mm (3/4")



7287L

overall height 84mm (3 5/16")  
max. width 31mm (1 1/4")  
keyhole height 18mm (11/16")



2637L

overall height 69mm (2 3/4")  
max. width 21mm (13/16")  
keyhole height 14mm (9/16")



6894L

overall height 74mm (2 15/16")  
max. width 25mm (1")  
keyhole height 15mm (5/8")



XF58BL (A202)

overall height 53mm (2 1/8")  
max. width 19mm (3/4")  
keyhole height 13mm (1/2")



F125L

overall height 41mm (1 5/8")  
max. width 21mm (13/16")  
keyhole height 17mm (11/16")



2994L



overall height 39mm (1 9/16")  
max. width 13mm (1/2")  
keyhole height 12mm (7/16")

8243L



overall height 60mm (2 3/8")  
max. width 16mm (5/8")  
keyhole height 16mm (5/8")

3428L



overall height 71mm (2 13/16")  
max. width 18mm (3/4")  
keyhole height 14mm (9/16")

X324L  
(A154)



overall height 52mm (2 1/16")  
max. width 18mm (3/4")  
keyhole height 13mm (1/2")

3753L



overall height 61mm (2 3/8")  
max. width 20mm (13/16")  
keyhole height 14mm (9/16")

3754L



overall height 59mm (2 3/8")  
max. width 26mm (1")  
keyhole height 14mm (9/16")

3013L



overall height 72mm (2 13/16")  
max. width 25mm (1")  
keyhole height 16mm (5/8")

8330L



overall height 86mm (3 3/8")  
max. width 27mm (1 1/16")  
keyhole height 20mm (3/4")

W192L



overall height 124mm (4 7/8")  
max. width 28mm (1 1/8")  
keyhole height 17mm (11/16")

X616L  
(A156)



overall height 113mm (4 7/16")  
max. width 25mm (1")  
keyhole height 19mm (3/4")

6230L



overall height 106mm (4 3/16")  
max. width 28mm (1 1/8")  
keyhole height 20mm (3/4")

X138L  
(A155)



overall height 85mm (3 3/8")  
max. width 25mm (1")  
keyhole height 15mm (5/8")

NB: cast without pin holes



3012L



overall height  
94mm (3 3/4")  
max.width  
24mm (15/16")  
keyhole height  
14mm (9/16")

3714L



overall height  
84mm (3 5/16")  
max.width  
21mm (13/16")  
keyhole height  
15mm (9/16")

3549L



overall height  
75mm (3")  
max.width  
22mm (7/8")  
keyhole height  
17mm (11/16")

2890L



overall height  
77mm (3 1/16")  
max.width  
23mm (15/16")  
keyhole height  
20mm (3/4")

3011L



overall height  
78mm (3 1/16")  
max.width  
19m (3/4")  
keyhole height  
17mm (11/16")

3010L



overall height  
80mm (3 3/16")  
max.width  
22mm (7/8")  
keyhole height  
16mm (5/8")

6199L



overall height  
89mm (3 1/2")  
max.width  
28mm (1 1/8")  
keyhole height  
19mm (3/4")

3009L



overall height  
92mm (3 5/8")  
max.width  
26mm (1")  
keyhole height  
17mm (11/16")

3008L



overall height  
91mm (3 5/8")  
max.width  
25mm (1")  
keyhole height  
18mm (3/4")

X487L (A153)



overall height  
102mm (4")  
max.width  
26mm (1 1/16")  
keyhole height  
21mm (13/16")

2297L



overall height  
117mm (4 5/8")  
max.width 23mm (15/16")  
keyhole height 21mm (13/16")

435L

overall height  
75mm  
(3")

max. width  
30mm  
(1 3/16")

keyhole height  
21mm  
(13/16")



3550L

overall height  
99mm  
(3 15/16")

max. width  
30mm  
(1 3/16")

keyhole height  
20mm  
(3/4")



7167L

overall height  
131mm  
(5 3/16")

max. width  
35mm  
(1 3/8")

keyhole height  
21mm  
(13/16")



2603L

overall height  
130mm  
(5 1/8")

max. width  
34mm  
(1 5/16")

keyhole height  
21mm  
(13/16")



1367L

overall height  
107mm  
(4 1/4")

max. width  
31mm  
(1 1/4")

keyhole height  
18mm  
(11/16")

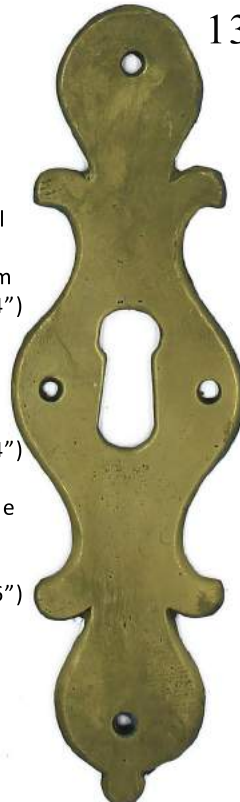

8154L

overall height  
99mm  
(3 7/8")

max. width  
36mm  
(1 7/16")

keyhole height  
18mm  
(11/16")





ESCUTCHEONS

2887L



overall height  
82mm (3 1/4")  
max.width  
28mm (1 1/8")  
keyhole height  
16mm (5/8")

1560L



overall height  
119mm (4 11/16")  
max.width  
31mm (1 1/4")  
keyhole height  
19mm (3/4")

3007L



overall height  
106mm (4 3/16")  
max.width  
45mm (1 3/4")  
keyhole height  
19mm (3/4")

3748L



overall height  
115mm (4 1/2")  
max.width  
32mm (1 1/4")  
keyhole height  
17mm (5/8")

6578L



overall height  
92mm (3 11/16")  
max.width  
33mm (1 5/16")  
keyhole height  
19mm (3/4")

6505AL



overall height  
85mm (3 3/8")  
max.width  
27mm (1 1/16")  
keyhole height  
17mm (11/16")

6505BL



overall height  
63mm (2 1/2")  
max.width  
18mm (3/4")  
keyhole height  
12mm (1/2")

2117L



overall height  
104mm (4 1/8")  
max.width  
35mm (1 3/8")  
keyhole height  
19mm (3/4")

8218L



overall height  
57mm (2 1/4")  
max.width  
21mm (13/16")  
keyhole height  
15mm (5/8")

3429L



overall height  
65mm (2 9/16")  
max.width  
19mm (3/4")  
keyhole height  
12mm (1/2")

2888L



overall height  
86mm (3 3/8")  
max.width  
25mm (1")  
keyhole height  
18mm (11/16")

1764L



overall height  
96mm (3 13/16")  
max.width  
28mm (1 1/8")  
keyhole height  
21mm (13/16")

2354L



overall height  
106mm (4 3/16")  
max.width  
22mm (7/8")  
keyhole height  
22mm (7/8")

6579L



overall height  
126mm (5")  
max.width  
32mm (1 5/16")  
keyhole height  
19mm (3/4")

2814L



overall height  
130mm (5 1/8")  
max.width  
35mm (1 3/8")  
keyhole height  
20mm (3/4")

2910L



overall height  
124mm (4 7/8")  
max.width  
29mm (1 3/16")  
keyhole height  
18mm (11/16")

2103L



overall height  
131mm (5 1/8")  
max.width  
31mm (1 3/16")  
keyhole height  
19mm (3/4")



2889L



overall height  
77mm (3 1/16")  
max.width  
21mm (13/16")  
keyhole height  
14mm (9/16")

1447L



overall height  
105mm (4 1/8")  
max.width  
29mm (1 1/8")  
keyhole height  
19mm (3/4")

X2266L  
(C164)



overall height 114mm (4 1/2")  
max.width 31mm (1 1/4")  
keyhole height 19mm (3/4")

2813L



overall height 115mm (4 9/16")  
max.width 29mm (1 1/8")  
keyhole height 16mm (5/8")

6932L



overall height  
84mm (3 3/8")  
max.width  
36mm (1 7/16")  
keyhole height  
20mm (13/16")

8164L



overall height  
97mm (3 7/8")  
max.width  
24mm (15/16")  
keyhole height  
16mm (5/8")

6963L



overall height 129mm (5 1/16")  
max.width 34mm (1 5/16")  
keyhole height 16mm (5/8")

1446L



overall height  
98mm (3 7/8")  
max.width  
36mm (1 7/16")  
keyhole height  
19mm (3/4")

F126L



overall height  
55mm (2 3/16")  
max.width  
11mm (7/16")  
keyhole height  
8mm (5/16")

F127L



overall height  
81mm (3 3/16")  
max.width  
13mm (9/16")  
keyhole height  
10mm (7/16")

7825L



overall height  
111mm (4 3/8")  
max.width  
17mm (11/16")  
keyhole height  
11mm (7/16")

3877L



overall height  
126mm (5")  
max.width  
14mm (9/16")  
keyhole height  
15mm (5/8")

6934L



overall height  
156mm (6 1/8")  
max.width  
47mm (1 7/8")  
keyhole height  
20mm (13/16")

2975L



overall height  
144mm (5 11/16")  
max.width  
41mm (1 5/8")  
keyhole height  
20mm (13/16")

7083L



overall height  
62mm (2 7/16")  
max.width  
18mm (3/4")  
keyhole height  
12mm (1/2")



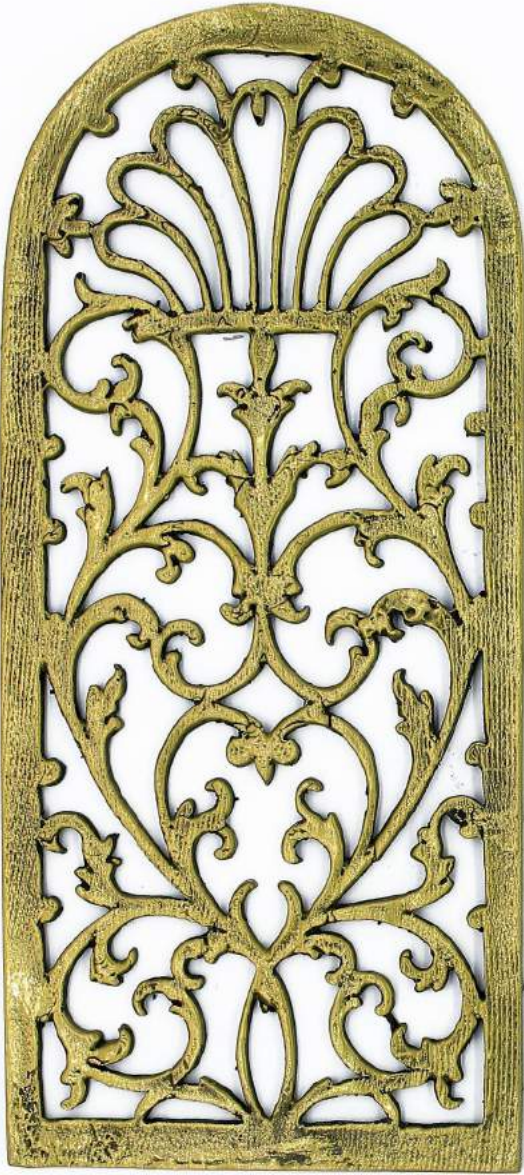

70mm (2 3/4")

3199L

overall height 157mm (6 3/16")

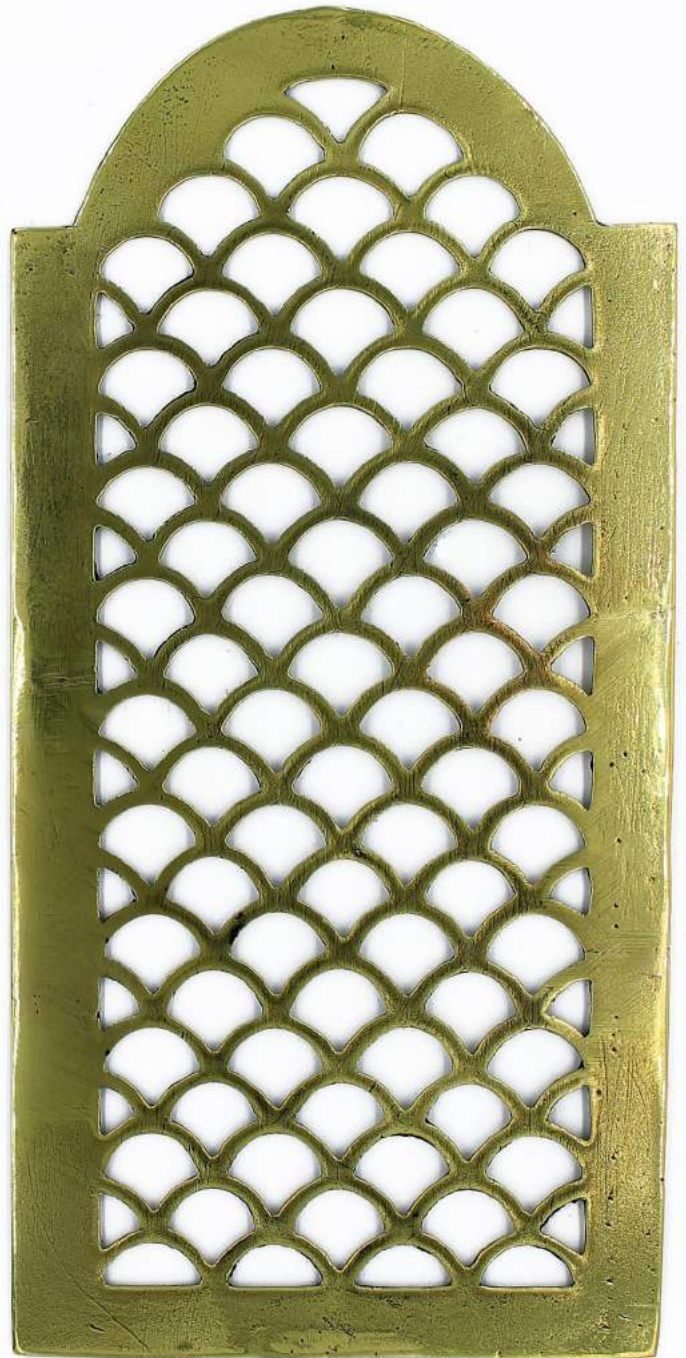

152mm  
(6")

87mm (3 7/16")

1866L

overall height 182mm (7 3/16")





161mm  
(6 5/16")

73mm (2 7/8")

**7604L**

overall height 189mm (7 3/8")



59mm (2 5/16")

**6599L**

overall height 142mm (5 9/16")



The following 5 pages show just a small selection of decorative mounts suitable for clocks. Further choices are available, so please ask if you don't see what you need here and we can search our extended range of mounts for you.

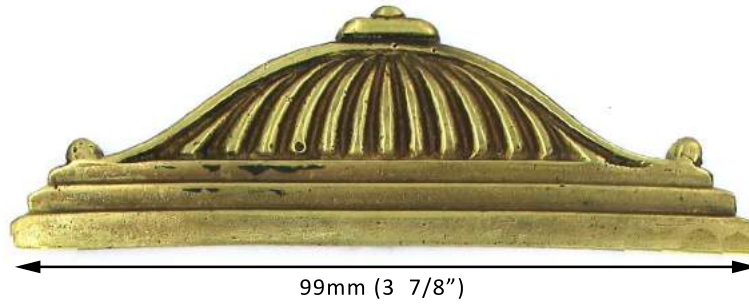

2421L

height 32mm (1 1/4")  
NB cast without fixings



*face on*

2824L



*showing reverse*

height 72mm (2 13/16")  
wing span 72mm (2 13/16")  
front to back 50mm (2")  
base is approx. 21mm (13/16") x 17mm (11/16")  
NB cast without fixings



*face on*

4005L



*showing reverse*

height 45mm (1 3/4")  
wing span 64mm (2 1/2")  
base is approx. 10mm (3/8") dia.  
NB cast without fixings



1459L

height 45mm (1 3/4")  
width is 41mm (1 5/8")  
NB this mount is flat backed  
and cast without fixings  
apart from a small locating pin

7119L



dia. 62mm  
(2 7/16")

2575L

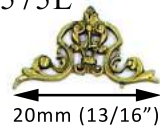

height  
11mm (7/16")

20mm (13/16")

2574L

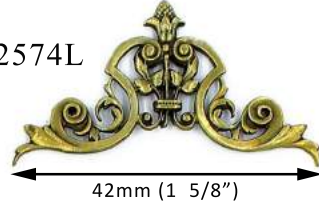

height  
23mm (7/8")

42mm (1 5/8")

2576L



height 14mm (9/16")  
width 33mm (1 5/16")

2579L



20mm  
(13/16")

19mm (3/4")  
height  
15mm (9/16")

1620L

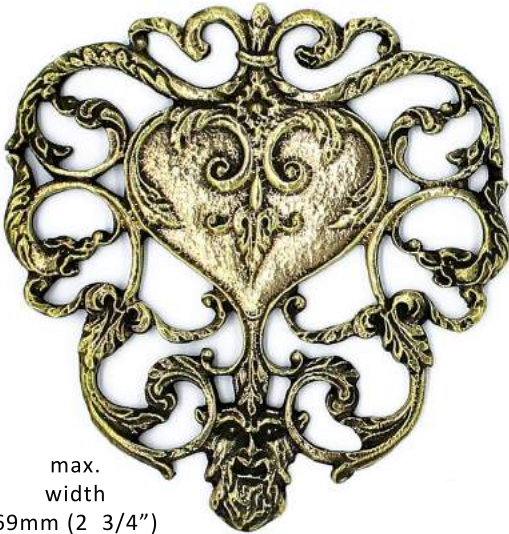

max.  
width  
69mm (2 3/4")  
overall height 72mm (2 7/8")

7914L



max. width 86mm (3 3/8")  
height 36mm (1 7/16")

3524L



65mm (2 9/16")

overall height 81mm (3 3/16")

3525L



overall height 78mm (3 1/16")  
max. width 50mm (2")

XF52AL  
(A269)



overall height 68mm (2 11/16")  
max. width 33mm (1 5/16")



MOUNTS

3943L

overall height 96mm (3 13/16")  
height from a. - b. = 48mm (1 7/8")



202mm (8")



3944L

overall height 57mm (2 1/4")  
overall width 248mm (9 3/4")

6988L

overall height 96mm (3 3/4")  
height of a. - b. = 77mm (3")  
overall width 244mm (9 5/8")

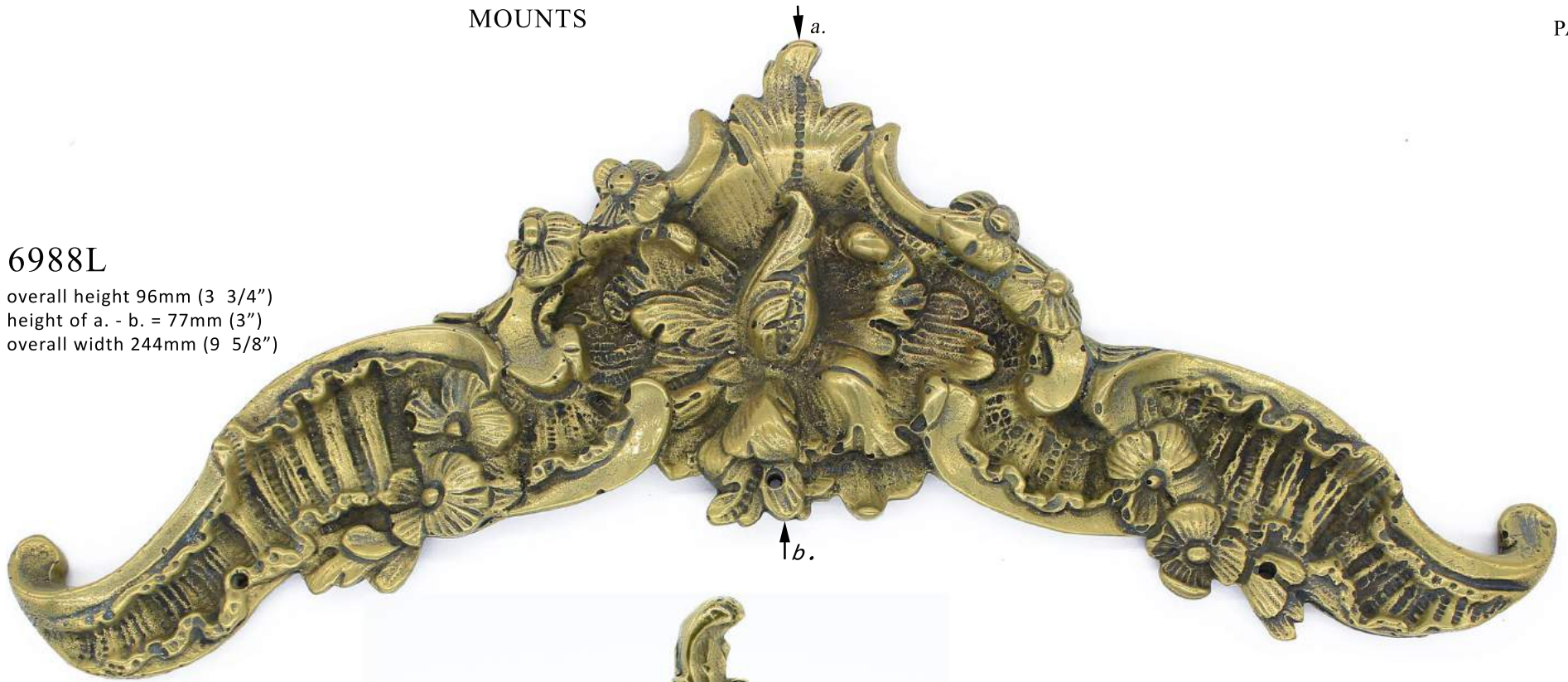

7745L

height  
98mm  
(3 7/8")



7745L looking top down,  
showing splay



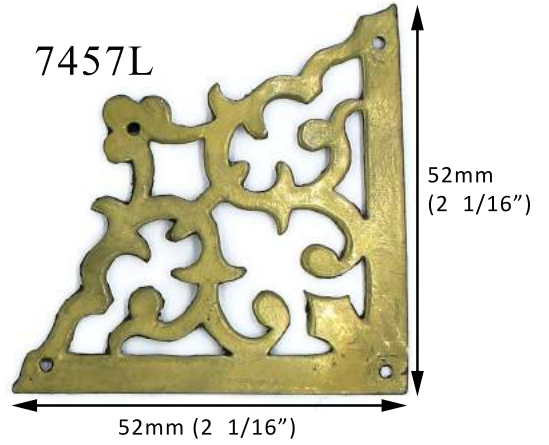
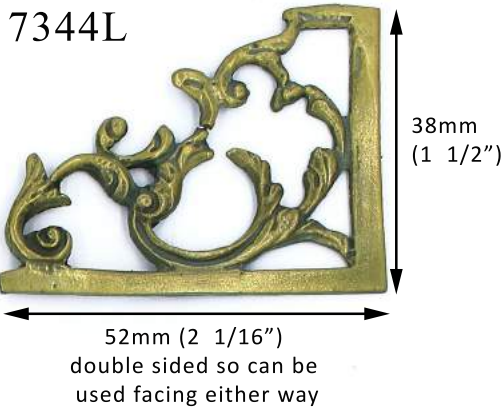

LANTERN CLOCK FRETS

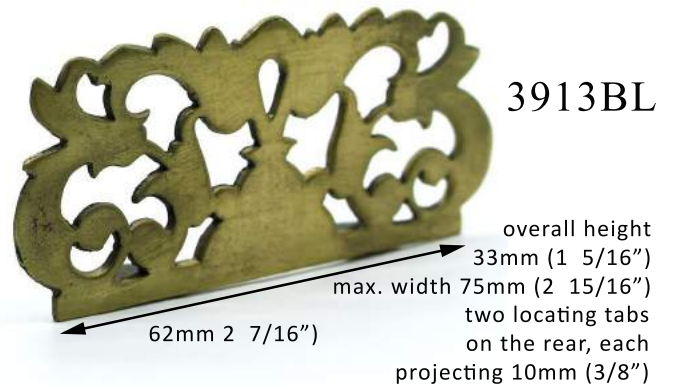

2757L



6264L



6228L



8181L



X3067L  
(C170)



3104L



3105L



6311AL



6311BL



3613L



2939L



7660L



7649L





QUARTER CAPITALS

8124L



7467L



7158L



7936L



3066L



800L



3103L



X801L  
(C169)



980L



X1021L  
(C171)



1583L



1584L



7897L





CORINTHIAN CAPITALS



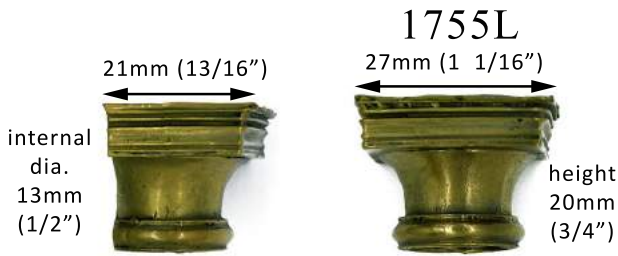

*showing flat backed profiles*

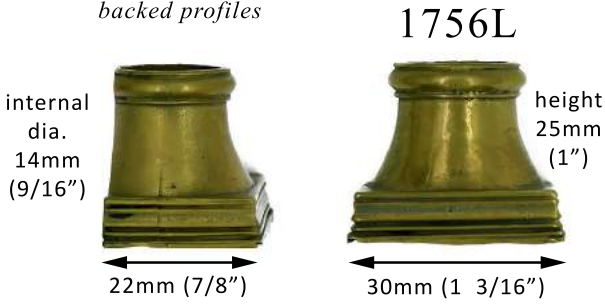



1734L

35mm (1 3/8")

height  
17mm (11/16")  
internal dia.  
16mm (5/8")



6182L

37mm (1 7/16")

height  
26mm (1")  
internal dia.  
19mm (3/4")



height  
15mm (9/16")  
internal dia.  
20mm (13/16")



37mm (1 1/2")

1733L

height  
20mm (13/16")  
internal dia.  
22mm (7/8")



41mm (1 9/16")

6181L

2295L

34mm (1 5/16")

height  
17mm (11/16")  
internal dia.  
17mm (11/16")



X3069  
(C167)

37mm (1 7/16")

height  
17mm (11/16")  
internal dia.  
22mm (7/8")



height  
15mm (9/16")  
internal dia.  
22mm (7/8")



36mm (1 7/16")

2294L

height  
18mm (11/16")  
internal dia.  
24mm (15/16")



40mm (1 9/16")

X3070  
(C168)

FULL CAPITALS

7236L



height  
22mm (7/8")  
internal dia.  
22mm (7/8")

7237L



height  
21mm (7/8")  
internal dia.  
23mm (15/16")

6470L

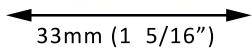

height  
16mm (5/8")  
internal dia.  
22mm (7/8")

8295L

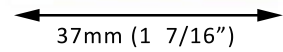

height  
15mm (9/16")  
internal dia.  
24mm (15/16")

2259L

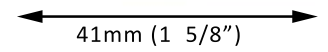

height  
16mm (5/8")  
internal dia.  
24mm (15/16")

2293L

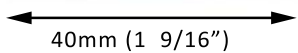

height  
21mm (7/8")  
internal dia.  
27mm (1 1/16")

1249L

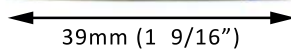

height  
18mm (11/16")  
internal dia.  
21mm (13/16")

1629L

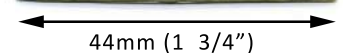

height  
20mm (3/4")  
internal dia.  
28mm (1 1/16")



THREE QUARTER CAPITALS

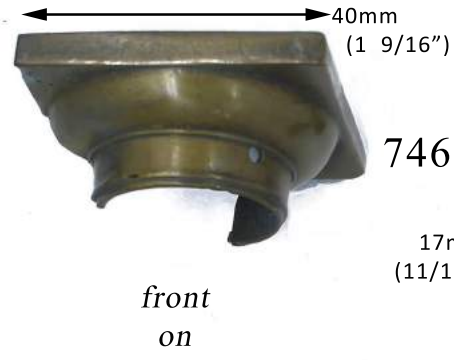

7469AL

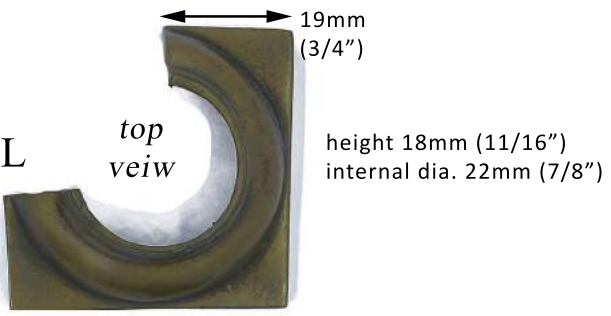

7469BL

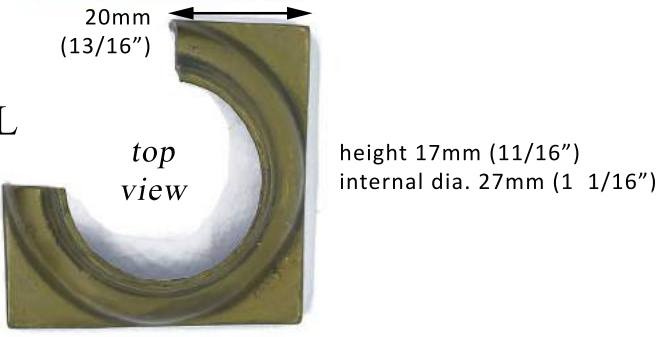

7773AL

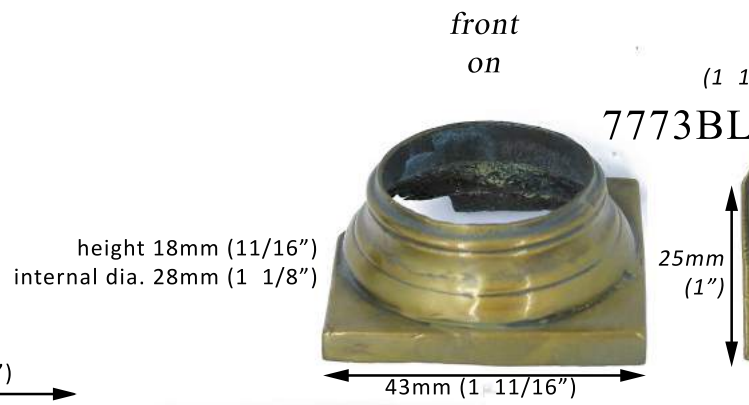
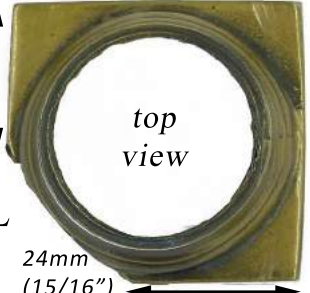

7773BL

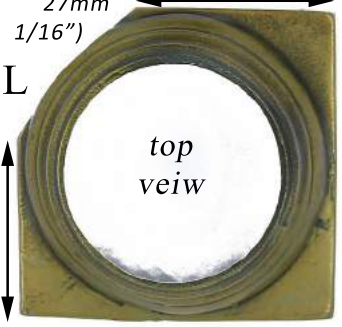

8265BL

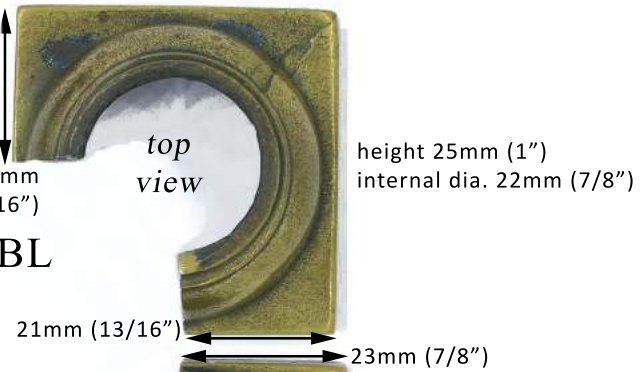

8265AL



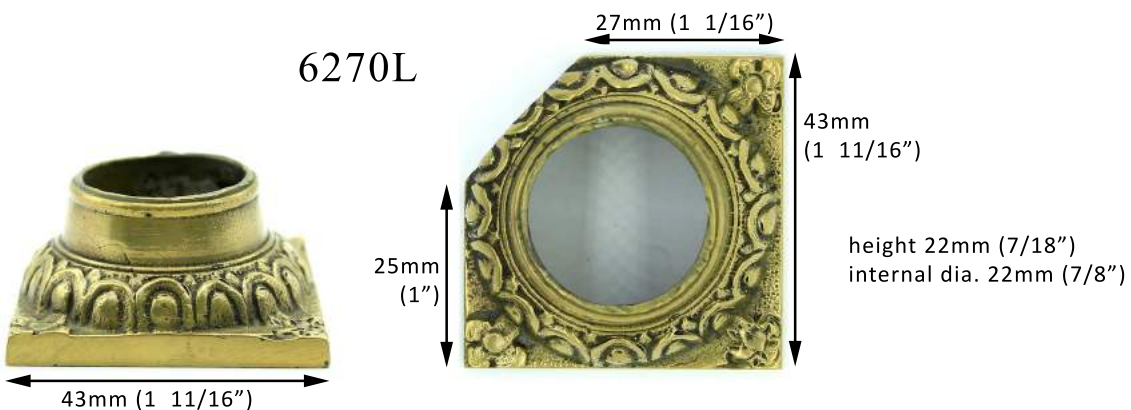
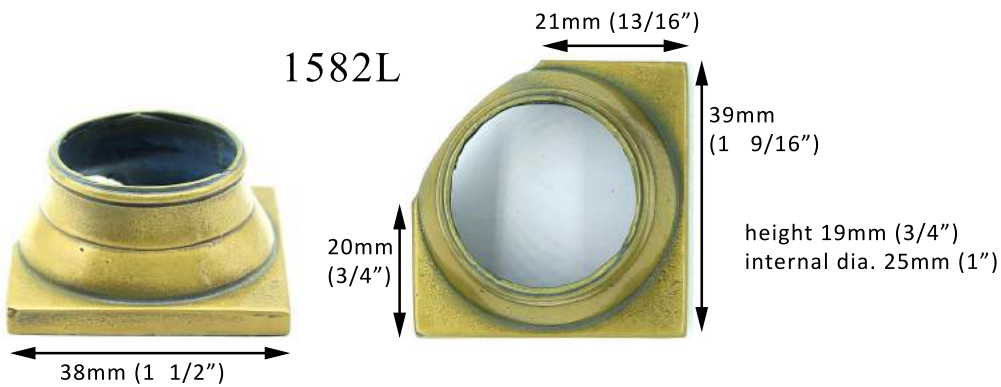
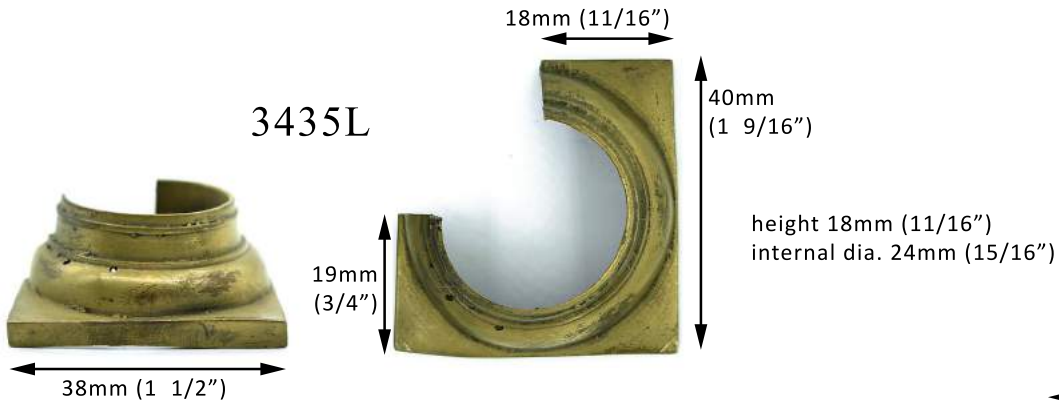



BALL FEET

6533L



height 27mm (1 1/16")  
ball dia. 19mm (3/4")  
dia. at neck  
10mm (7/16")  
cast with pilot hole  
in top

2362L



height 25mm (1")  
ball dia. 19mm (3/4")  
dia. at neck  
15mm (9/16")  
cast with threaded  
hole in top

342L



height (exc.screw)  
22mm (7/8")  
ball dia. 19mm (3/4")  
dia. at neck  
14mm (9/16")

7125L



height (exc.screw)  
29mm (1 1/8")  
ball dia. 18mm (3/4")  
dia. at neck  
17mm (11/16")

1179L



height (exc.screw)  
33mm (1 5/16")  
ball dia. 21mm (13/16")  
dia. at neck  
10mm (3/8")

1988L



height 25mm (1")  
ball dia. 24mm (15/16")  
dia. at neck 16mm (5/8")  
cast with threaded  
hole in top

8222L



height (exc.screw) 27mm (1 1/16")  
ball dia. 30mm (1 3/16")  
hollow inside

6514L



height (exc.stub) 30mm (1 3/16")  
max. dia. 31mm (1 1/4")  
dia. at neck 17mm (11/16")

X2171L  
(C139)



height (exc.screw)  
20mm (13/16")  
ball dia. 22mm (7/8")

8236L



height (exc.screw) 38mm (1 1/2")  
ball dia. 42mm (1 11/16")  
hollow inside

3419L



height 17mm (11/16")  
max. dia. 21mm (13/16")  
cast with pilot hole  
in top

8270L



height (exc.screw) 13mm (1/2")  
max. dia. 30mm (1 3/16")

8173L



height 10mm (7/16")  
max. dia. 22mm (7/8")  
hollow inside

8221L



height 6mm (1/4")  
max. dia. 13mm (1/2")  
hollow inside

7559L



height (exc.pin) 11mm (7/16")  
max. dia. 27mm (1 1/16")

7510L



height (exc.screw) 20mm (13/16")  
max. dia. 37mm (1 7/16")

F150L



height 6mm (1/4")  
max. dia. 26mm (1 1/16")  
has 3 small screw  
holes in base

7608L



height 16mm (5/8")  
max. dia. 30mm (1 3/16")  
cast with threaded  
hole right through

8040L



height (exc. pin) 10mm (7/16")  
max. dia. 34mm (1 5/16")



BRACKET FEET



**F156L**  
each top edge to corner  
21mm (7/8")  
height 9mm (3/8")



**F152L**  
each top edge to corner  
22mm (7/8")  
height 13mm (1/2")



**F151L**  
each top edge to corner  
18mm (11/16")  
height 10mm (7/16")



**7109L**  
each top edge to corner  
30mm (1 1/4")  
height 14mm (9/16")



**7932L**  
each top edge to corner  
40mm (1 5/8")  
height 13mm (1/2")



**7061L**  
each top edge to corner  
38mm (1 1/2")  
height 22mm (7/8")



**7981L**

each top edge to corner  
42mm (1 11/16")  
height 26mm (1")



**7497L**

top measures 29mm (1 1/8") square  
(excluding outer edge of screw tab)  
internal measurement is 19mm (3/4")  
by 20mm (13/16")  
height 27mm (1 1/16")

there is a notch at the rear edge under  
the screw hole to facilitate fitting



6090L

10mm (3/8")

height 17mm (11/16")  
width across paw 20mm (13/16")  
overall length 30mm (1 3/16")  
length of fixing platform 17mm (11/16")



6664L

13mm (9/16")

height 18mm (3/4")  
width across paw 25mm (1")  
overall length 36mm (1 7/16")  
length of fixing platform 18mm (3/4")



6466L

10mm (3/8")

height 12mm (1/2")  
width across paw 30mm (1 3/16")  
overall length 33mm (1 5/16")  
length of fixing platform 16mm (5/8")



3939L

18mm (3/4")

height 16mm (5/8")  
width across paw 18mm (3/4")  
overall length 43mm (1 11/16")  
length of fixing platform 24mm (15/16")



8131L

14mm (9/16")

height 19mm (3/4")  
width across paw 25mm (1")  
overall length 34mm (1 3/8")  
length of fixing platform 16mm (5/8")

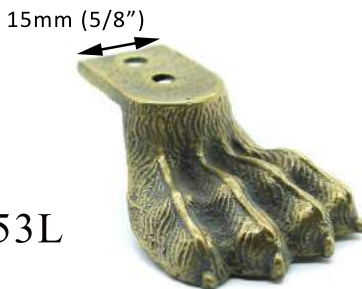

F153L

15mm (5/8")

height 18mm (3/4")  
width across paw 30mm (1 3/16")  
overall length 46mm (1 13/16")  
length of fixing platform 22mm (7/8")



W133L

34mm (1 3/8")

28mm  
(1 1/8")

height 16mm (5/8")  
width across paw 24mm (15/16")  
overall length 54mm (2 3/16")  
length of fixing platform 39mm (1 9/16")





height 30mm (1 1/4")  
width across paw 31mm (1 1/4")  
overall length 50mm (2")  
length of fixing platform 24mm (15/16")



height 40mm (1 9/16")  
width across paw 23mm (15/16")  
overall length 57mm (2 1/4")  
length of fixing platform 21mm (13/16")



height 38mm (1 1/2")  
width across paw 50mm (2")  
overall length 69mm (2 3/4")  
length of fixing platform 34mm (1 3/8")



height 46mm (1 13/16")  
width across paw 55mm (2 3/16")  
overall length 74mm (2 15/16")  
length of fixing platform 41mm (1 5/8")



height 27mm (1 1/16")  
width across paw 50mm (2")  
overall length 60mm (2 3/8")  
length of fixing platform 29mm (1 1/8")

6089L



each top edge to corner  
21mm (7/8")  
height 15mm (9/16")  
width across paw 12mm (1/2")

3466L



each top edge to corner  
25mm (1")  
height 22mm (7/8")  
width across paw 29mm (1 1/8")

X797L  
(B31)

each top edge to corner  
36mm (1 7/16")  
height 27mm (1 1/16")  
width across paw 21mm (7/8")

1748L



each top edge to corner  
40mm (1 9/16")  
height 33mm (1 5/16")  
width across paw 28mm (1 1/8")

1675L



each top edge to corner  
54mm (2 1/8")  
height 25mm (1")  
width across paw 30mm (1 3/16")

6861L



each top edge to corner  
79mm (3 1/8")  
height 39mm (1 9/16")  
width across paw 22mm (7/8")



2821L



each top edge to corner 24mm (15/16")  
height 14mm (9/16")  
NB cast without screw holes

2194L



from corner to each end  
56mm (2 1/4")  
overall height 61mm (2 7/16")  
would give lift of (ie height to  
platform) of 29mm (1 1/8")

*has platform  
positioned  
half way up height*



8090L

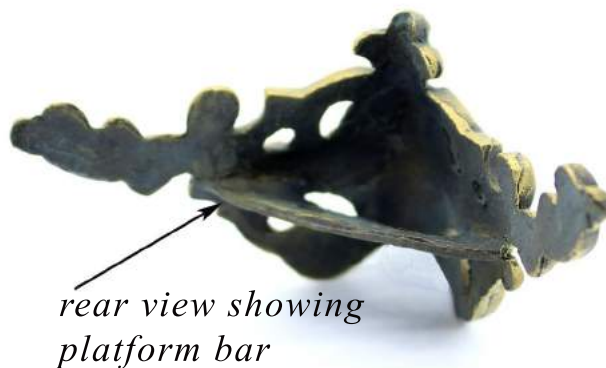

*rear view showing  
platform bar*

from near front corner to each end  
61mm (2 7/16")  
overall height 43mm (1 11/16")  
would give lift of (ie height to  
platform) of 26mm (1 1/16")



1034L

from corner to each edge:  
 46mm (1 13/16") - left side  
 49mm (1 15/16") - right side  
 overall height 26mm (1 1/16")



6219L

from corner to each end 100mm (4")  
 overall height 69mm (2 3/4")  
 would give lift of (ie height to  
 platform) of 57mm (2 1/4")



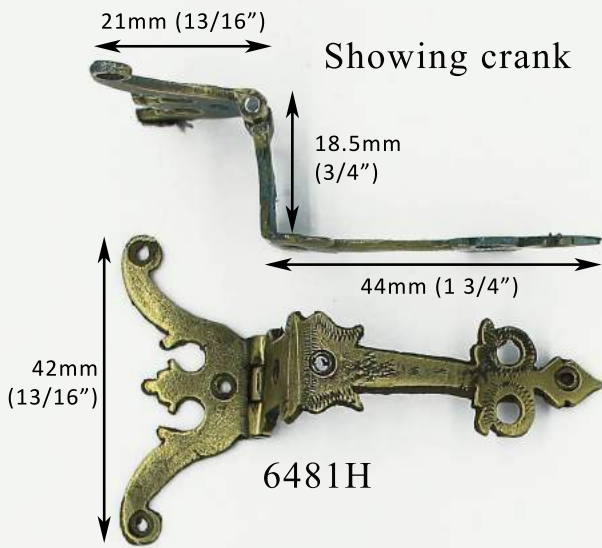

Showing crank

6481H



2857H

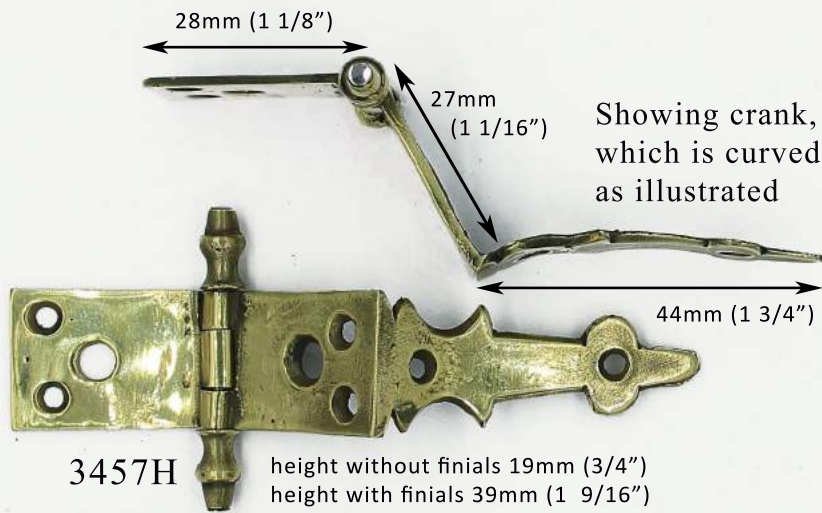

Showing crank, which is curved as illustrated

3457H

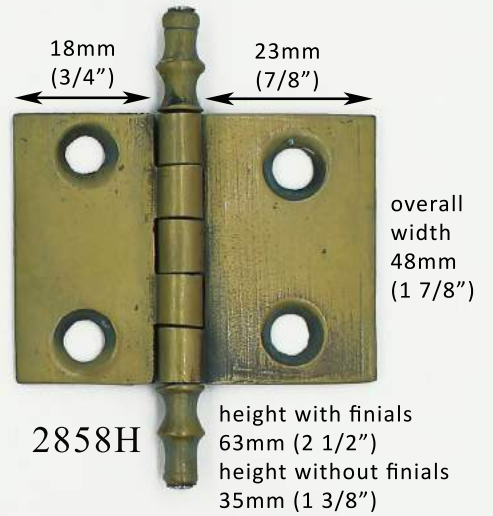

2858H

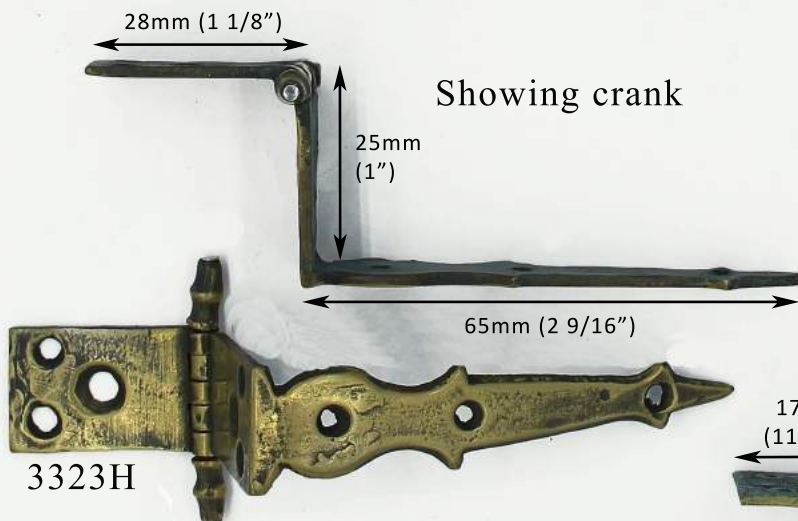

Showing crank

3323H

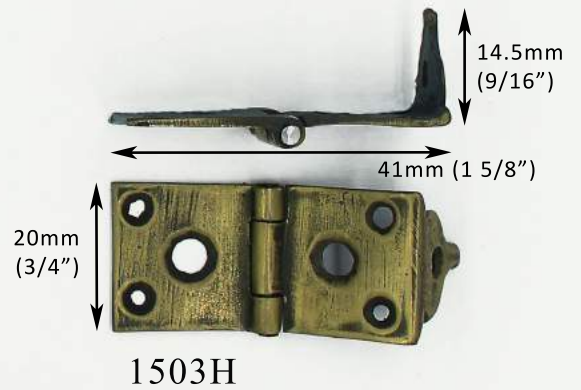

1503H

height without finials 16mm (5/8")  
height with finials 35mm (1 3/8")

height without finials 20mm (13/16")  
height with finials 39mm (1 1/2")

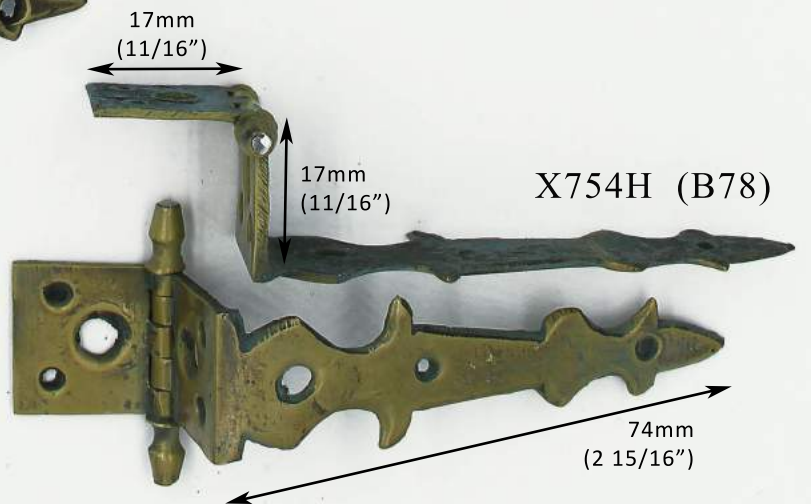

X754H (B78)

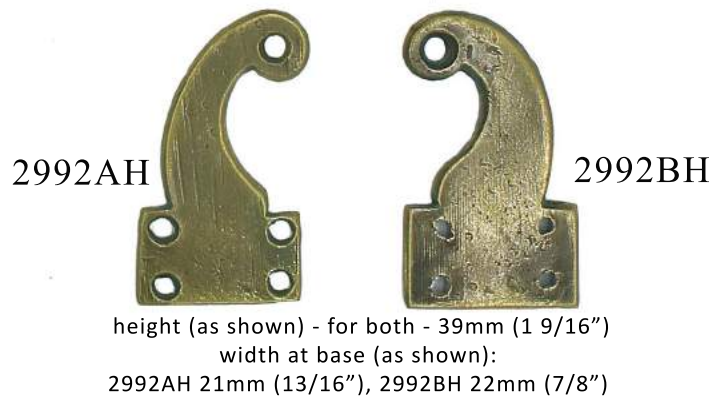
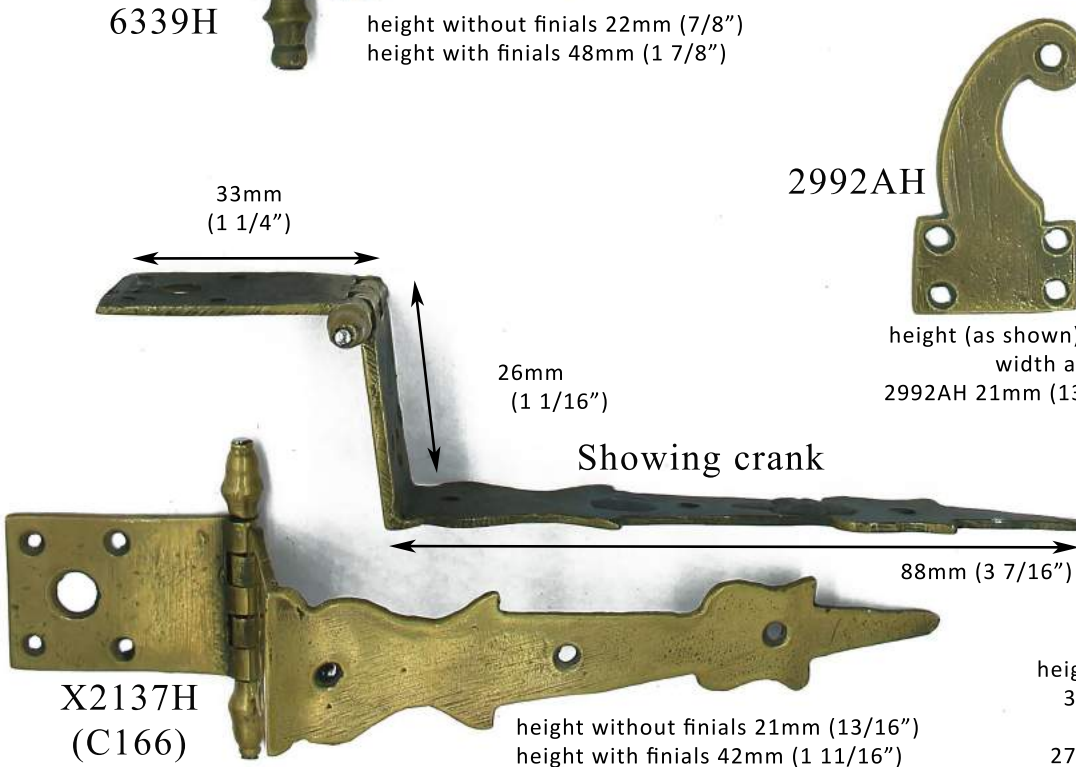
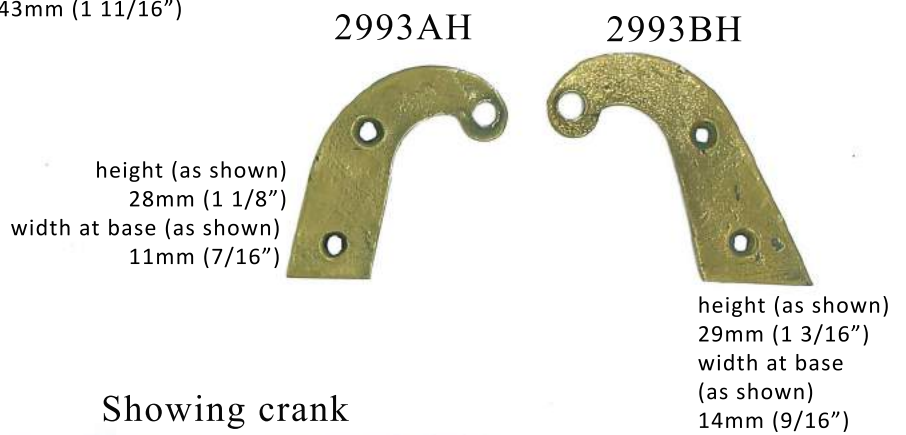
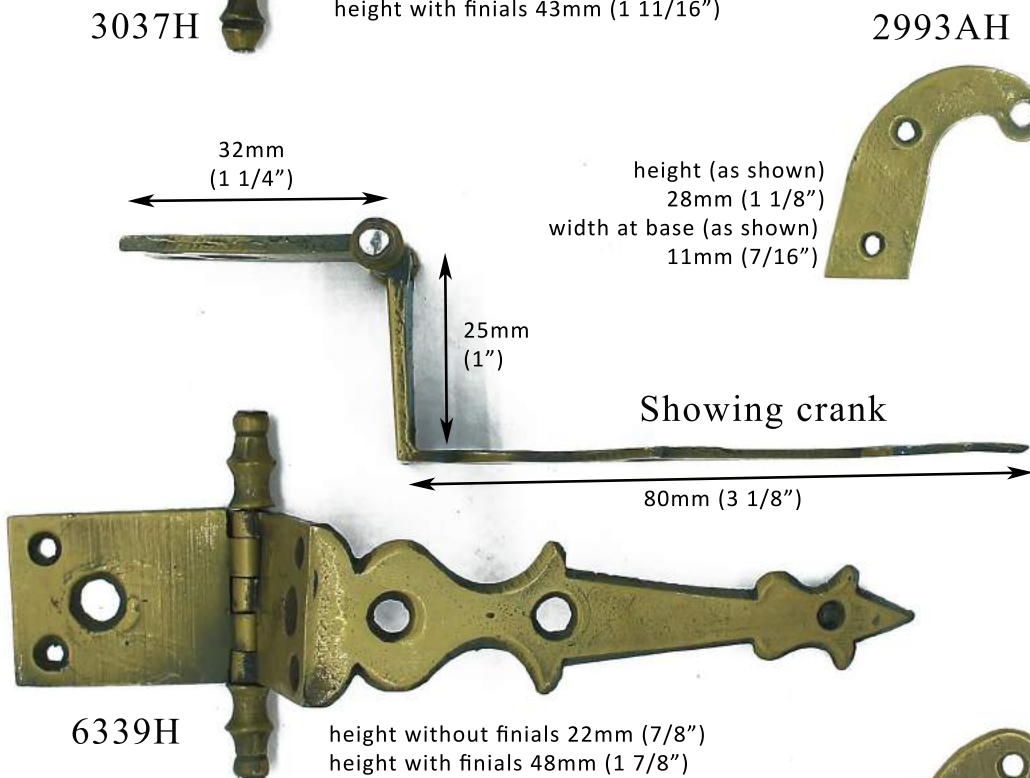
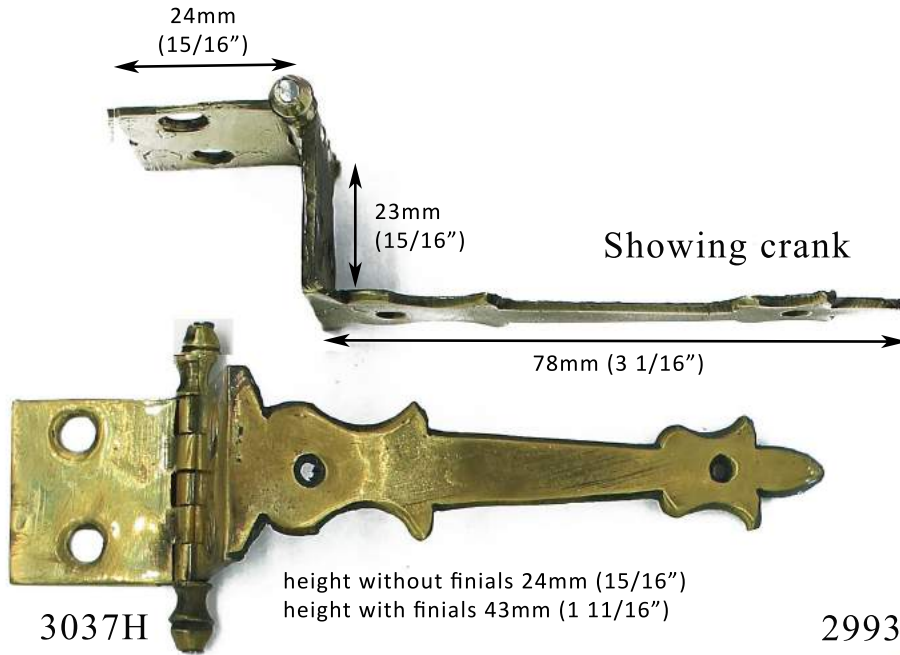



CLOCK CARRYING HANDLES

F157L



overall height 27mm (1 1/16")  
max. width 34mm (1 5/16")  
block width 8mm (5/16")

this handle is cast without fixing threads which can be added to required specifications, please ask for a quote

X3543L  
(C165)



overall height 52mm (2 1/16")  
max. width 74mm (2 15/16")  
block width 11mm (7/16")

this handle is cast without fixing threads which can be added to required specifications, please ask for a quote

3833A/6490L

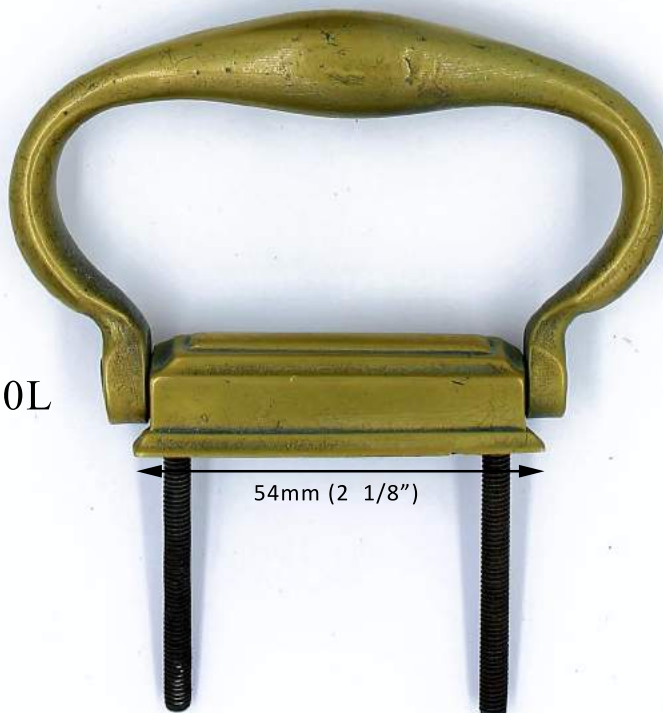

overall height (exc. threads) 57mm (2 1/4")  
max. width 88mm (3 1/2")  
block width 19mm (3/4")

this handle, assembled as shown, has a block which is cast with fixing threads at 40mm (1 5/8") length and 44mm (1 3/4") centre to centre

a block to sit over a shallow curve is also available - please enquire with item reference 3833BL for more information



8242L

overall height (exc. thread)  
52mm (2 1/16")  
max. width 87mm (3 7/16")  
block width 15mm (5/8")

this handle is cast with a  
single fixing thread as shown  
of 53mm (2 1/8") length



F148L



*handle pivots on  
ball and socket assembly*

overall height 43mm (1 3/4") max. width 69mm (2 3/4")  
this handle is cast without fixing threads which can be added to required specifications,  
please ask for a quote



1770L



*top view with  
handle resting*

plate width 50mm (1 15/16") max. plate length 53mm (2 1/16")  
overall height with handle standing 43mm (1 3/4")  
plate has 4 pin holes for surface mounting



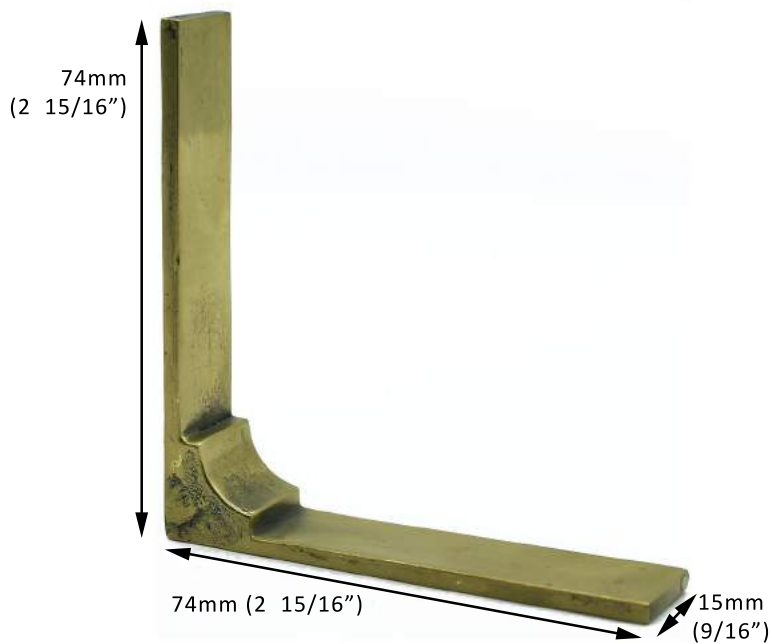

7365L



6601L

359L



measures  
57mm (2 1/4")  
x 16mm (5/8")

FOR MORE HOOKS  
AND EYES PLEASE VISIT  
OUR ONLINE SHOP



XW130ABL

for hook and  
eye together

or quote item C129  
to buy eye only  
and item C125  
to buy hook only

hook: end to end 57mm (2 1/4")

eye: ext. dia. of eye 12mm (1/2")  
total length 15mm (9/16")